

CITY of NOVI CITY COUNCIL

**Agenda Item C
April 18, 2011**

SUBJECT: Approval to award the contract for the 2011 Spring Tree & Landscape Planting to RC Tuttle Refinishing, Co., the lowest bidder in the amount of \$87,115.

SUBMITTING DEPARTMENT: Community Development

CITY MANAGER APPROVAL: 

| | |
|-----------------------------|---|
| EXPENDITURE REQUIRED | \$79,717 Landscape Planting \$7395 Welcome & Wayfinding Signage Plantings |
| AMOUNT BUDGETED | \$250,000 Landscape Plantings \$18,000 Welcome & Wayfinding Signage Plantings |
| LINE ITEM NUMBER | 209-000.00-939.260 Tree Fund 101-265.00-971.200 Welcome & Wayfinding Signage Plantings |

BACKGROUND INFORMATION:

The annual spring planting for 2011 involves a wide variety of plantings in multiple locations. Each project was conceived in keeping with the City's commitment to the natural environment, as well and the continued effort to expand on the positive community image. Included in the contract are the following:

- Continued planting of new and replacement street trees in subdivisions. Residents receiving new trees will be notified prior to installation.
- Installation of native tree species within Fuerst Park. In a continuing effort, the City is educating residents about responsible landscaping while improving the aesthetics of the community park.
- Perennial plantings on the Civic Center grounds in an effort to beautify and reduce annual plantings and costs. Plantings installed last year will already have a significant impact this growing season.
- Fifteen (15) native trees will be supplied for the community Arbor Day event on May 7th. The trees will be planted by volunteer residents in Brookfarm Park adjacent to Orchard Hills Elementary School.
- Perennial plantings and small landscape beds around the six newly installed Wayfinding Signs at the Civic Center and at six Welcome Sign locations throughout the City. The planted landscape beds will improve the appeal of the signs and will serve to shield potential harm by ongoing maintenance operations. The plantings and beds are designed to require a low level of care.
- Landscape trees along two miles of the M-5 median between Twelve and Fourteen Mile Roads. In a cooperative effort with MDOT, Novi will be installing 200 trees to add to the visual appearance of the roadway. Already this spring, the City has worked with MDOT on the State funded installation of 200 trees and 1000 shrubs along the newly installed public bike trail between Thirteen and Fourteen Mile Roads.

Nine (9) bids were received and opened on March 30, 2011 following a public bid solicitation period. Bid submittals and references were reviewed by staff within the Department of Public Services and Community Development. The lowest bidder is RC Tuttle Refinishing, Inc. RC Tuttle's bid is recommended as being in the best interest of the City as it is responsive and it is the lowest price. A summary of the nine bids is as follows:

| | RC Tuttle | Panoramic | M & J Cont. | Great Lakes | Marine City | Green Valley | Reliable | Chas F. Irish | Sallient |
|---|---------------|---------------|-------------------|---------------|----------------|----------------|----------------|-------------------|----------------|
| Bid 1-3 Alt. A Total (2 yr warranty) | 67,160 | 65,480 | 62,462.50 | 63,143 | 76,605 | 76,602 | 70,710.70 | 87,218 | 82,385 |
| Alt. B Total (aeration sleeves) | 7,878 | 8,484 | 19,695 | 13,332 | 12,120 | 17,574 | 26,664 | 22,422 | 24,240 |
| Bid #4 - Brookfarm Tree (no warranty) | 2,675 | 2,210 | included in Alt A | 2,640 | 3,250 | 3,395 | 2,812 | included in Alt A | 1,950 |
| Bid #5 - Civic Center Perennials | 1,617 | 1,374 | 1,331.45 | 2,700 | 1,715 | 1,601 | 2,170 | 1,955 | 4,322 |
| Bid #8 - Shrubs | 387 | 292 | 323 | 700 | 329.50 | 504 | 571.34 | 410 | 573 |
| SUBTOTAL | 79,717 | 77,840 | 83,812 | 82,515 | 94,020 | 99,676 | 102,928 | 112,005 | 113,470 |
| | | | | | | | | | |
| Bid #6 - Wayfinding Signs Beds/Planting | 1,620 | 1,847 | 828 | 2,134 | 1,410 | 1,359 | 1,867 | 1,224 | 2,409 |
| Bid #7 - Welcome Sign Beds/Planting | 5,778 | 7,461 | 3,937 | 4,430 | 6,668 | 7,488 | 6,447 | 5,154 | 12,458 |
| SUBTOTAL | 7,398 | 9,308 | 4,765 | 6,564 | 8,078 | 8,847 | 8,314 | 6,378 | 14,867 |
| | | | | | | | | | |
| Total - All bids (2 yr warranty on bids with warranties) | 87,115 | 87,148 | 88,577 | 89,079 | 102,098 | 108,523 | 111,242 | 118,383 | 128,337 |

RECOMMENDED ACTION: Approval to award the contract for the 2011 Spring Tree & Landscape Planting to RC Tuttle Refinishing, Co., the lowest bidder in the amount of \$87,115.

| | 1 | 2 | Y | N |
|-------------------------|---|---|---|---|
| Mayor Landry | | | | |
| Mayor Pro Tem Gatt | | | | |
| Council Member Fischer | | | | |
| Council Member Margolis | | | | |

| | 1 | 2 | Y | N |
|-----------------------|---|---|---|---|
| Council Member Mutch | | | | |
| Council Member Staudt | | | | |
| Council Member Wrobel | | | | |

CONTRACT – 2011 SPRING LANDSCAPE PLANTING

This Agreement shall be considered as made and entered into as of the date of the last signature (“Effective Date”), and is between the City of Novi, 45175 W. Ten Mile, Novi, Michigan 48375 “City”, and R.C. Tuttle Refinishing Co., whose address is 2475 S. Hickory Ridge Tr., Milford, MI 48380, “Contractor.”

Work. For and in consideration of payment by the City as provided under the Payment Section of this Contract, Contractor shall perform the work described on and in the Work Specifications listed in “Exhibit A”, which is a part of this Contract, in a competent, efficient, timely, good and workmanlike manner and in compliance with the following terms and conditions.

Permits. The work to be performed includes applying and paying for, and obtaining issuance of all required permits and satisfying all requirements or conditions for such permits.

Bonds and Insurance. This Contract is conditioned on Contractor securing and maintaining the liability insurance specified in the Bid Specifications, which are a part of this Contract, which shall be confirmed by Certificate(s) of Insurance, with said coverages to be maintained for the life of this Contract and the City entitled to thirty (30) days written notice of any cancellations or changes. Contractor shall also supply payment, performance, and maintenance bonds as required, in a form acceptable to the City.

Time of Work. All Insurance requirements shall be satisfied within 14 days, and work shall be completed within 30 days of the Effective Date of this Contract. These time limits are of the essence of this Contract and failure to meet them shall permit City to terminate this Contract whether or not work has been commenced.

Payment. The City agrees to pay the Contractor the sum of \$87,115, payment to be made after satisfactory completion of the work and within thirty (30) days of receiving a final bill or invoice for the work from the Contractor, accompanied by a sworn statement and full unconditional waivers of lien, confirming that all subcontractors and any material suppliers have been paid in full.

Changes. Any changes in the provisions of this Contract must be in writing and signed by the City and Contractor.

Liability. Contractor shall be liable for any injury or damage occurring on account of the performance of its work under this Contract. Consistent with this liability, the Contractor agrees to defend, pay on behalf of, and hold harmless the City, its agents, and others working on its behalf against any and all claims, demands, suits, losses and settlements, including actual attorney fees incurred and all costs connected therewith, for any damages which may be asserted, claimed or recovered against the City by reason of personal injury and/or property damages which arises out of or is in any way connected or associated with this Contract.

Inspections, Notices and Remedies Regarding Work. During the performance of the work by Contractor, City shall have the right to inspect the work and its progress to assure that it complies with this Contract. If such inspections reveal a defect in the work performed or other default in this Contract, City shall provide Contractor with written notice to correct the defect or default within a specified number of days of the notice. Upon receiving such a notice, Contractor shall correct the specified defects or defaults within the time specified. Upon a failure to do so, the City may terminate this Contract by written notice and finish the work through whatever method it deems appropriate, with the cost in doing so a valid claim and charge against Contractor, or, preserve the claims of defects or defaults without termination by written notice to Contractor.

Demolition Disposal Requirements. The Contractor shall perform all work and dispose of all materials in compliance with all provisions of applicable federal, state, county and City environmental laws. This obligation includes lawful disposal of all material, with a condition of the City's payment obligation being Contractor delivering to City copies of written documents from the licensed landfill or disposal site, confirming the dates, quantities and types of demolition debris disposed of, the disposal costs and that those costs have been paid in full by Contractor.

Compliance with Laws. This Contract and all of Contractor's work and practices shall be subject to all applicable state, federal and local laws, rules or regulations, including without limitation, those which apply because City is a public governmental agency or body. Contractor represents that it is in compliance with all such laws and eligible and qualified to enter into this Contract.

Governing Law. This Contract shall be governed by the laws of the State of Michigan.

Assignment. Contractor shall not assign this Contract or any part thereof without the written consent of the City.

Successors and Assigns. This Contract shall be binding on the parties, their successors, assigns and legal representatives.

Notices. Written notices under this Contract shall be given to the parties at their addresses on page one by personal or registered mail delivery to the attention of the following persons:

City: Clay Pearson, City Manager and Maryanne Cornelius, City Clerk

Contractor: Robert Sopsich, Vice President

Contract Termination. The City may terminate and/or cancel this contract (or any part thereof) at any time during the term, any renewal, or any extension of this contract, upon thirty (30) days written notice to the Contractor, for any reason, including convenience without incurring obligation or penalty of any kind. The effective date for termination or cancelation shall be clearly stated in the written notice. In the event of termination Contractor shall be paid as compensation in full for services performed to that date an amount calculated for that particular project. Such amount shall be paid by the City upon Contractor delivering or otherwise making available to the City all data, drawings, specifications, reports, estimates, summaries, and such

other information and materials as may have been prepared and/or accumulated by Contractor in performing the services up to the date of termination.

Waivers. No waiver of any term or condition of this Contract shall be binding and effective unless in writing and signed by all parties, with any such waiver being limited to that circumstance only and not applicable to subsequent actions or events.

WITNESS AND DATES
OF SIGNATURES:

CITY OF NOVI

By: David B. Landry
Its: Mayor

Date: _____

By: Maryanne Cornelius
Its: Clerk

Date: _____

CONTRACTOR
R.C. Tuttle Refinishing Co.

By: Robert Sopsich
Its: Vice President

Date: _____

Rc Tattle

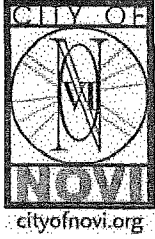

CITY OF NOVI
2011 SPRING LANDSCAPE PLANTING

OFFICIAL BID FORM
BID #1: Subdivision Tree Plantings

All trees 2.5 inch caliper unless specified otherwise.

Trees must be single stemmed tree-form unless requested otherwise by the City.

Locations are throughout the City of Novi and will be specified by City Staff prior to installations.

| Acceptable species of Plant Material | # of Trees | Source /Phone # | Unit Price (1 Yr.) | TOTAL | Unit Price (2 Yr.) | TOTAL ALT. A |
|---|------------|------------------------|--------------------|------------------|--------------------|------------------|
| ACER freemanii 'Autumn Blaze' (Autumn Blaze Maple) | 5 | R.C. Tattle Baldwin | 235.00 | 1,175.00 | 230.00 | 1,250.00 |
| LIRIODENDRON tulipifera (Tuliptree) | 10 | '' | 240.00 | 2,400.00 | 235.00 | 2,350.00 |
| QUERCUS bicolor (Swamp White Oak) | 5 | '' | 260.00 | 1,300.00 | 275.00 | 1,375.00 |
| SYRINGA 'Americana' (Japanese Tree Lilac) | 10 | '' | 245.00 | 2,450.00 | 260.00 | 2,600.00 |
| ULMUS X 'Homestead' (Homestead Elm) | 10 | '' | 245.00 | 2,450.00 | 260.00 | 2,600.00 |
| ZELKOVA serrata 'Village Green' (Zelkova) | 10 | '' | 235.00 | 2,350.00 | 250.00 | 2,500.00 |
| TOTALS | 50 | | | 12,125.00 | | 12,875.00 |

| Alternate B | Qty. | Source /Phone # | Unit Price | TOTAL |
|--|------|--------------------|------------|----------|
| 15" Standard Rootwell Pro 318D aeration sleeve (4 per tree) | 200 | Seiber Engineering | 6.50 | 1,300.00 |

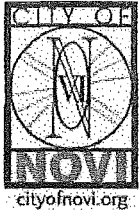

CITY OF NOVI
2011 SPRING LANDSCAPE PLANTING

OFFICIAL BID FORM
BID #2: Fuerst Park Tree Plantings

All trees 2.5 inch caliper unless specified otherwise.
Trees must be single stemmed tree-form unless requested otherwise by the City.
City staff will stake all plant installation locations prior to planting.

| Acceptable species of Plant Material | # of Trees | Source /Phone # | Unit Price (1 Yr.) | TOTAL | Unit Price (2 Yr.) | TOTAL ALT. A |
|---|------------|---------------------------|--------------------|-----------------|--------------------|-----------------|
| Acer saccharum 'Green Mountain' (Green Mountain Sugar Maple) | 3 | R.C. Jubille / Baldwin | 235.00 | 705.00 | 250.00 | 750.00 |
| Aesculus hippocastanum 'Ruby Red' (Ruby Red Horsechestnut) | 3 | " | 270.00 | 810.00 | 285.00 | 855.00 |
| Picea pungens (Blue Spruce) 6'-8' | 11 | " | 160.00 | 1,760.00 | 175.00 | 1,925.00 |
| Pinus nigra (Austrian Pine) 6'-8' | 5 | " | 185.00 | 925.00 | 200.00 | 1,000.00 |
| Pinus strobus (White Pine) 6'-8' | 5 | " | 180.00 | 900.00 | 195.00 | 975.00 |
| Quercus rubra (Red Oak) | 3 | " | 235.00 | 705.00 | 250.00 | 750.00 |
| Tilia Americana (American Basswood) | 3 | " | 240.00 | 720.00 | 255.00 | 765.00 |
| TOTALS | 33 | | | 6,525.00 | | 7,020.00 |

| Alternate B | Qty. | Source /Phone # | Unit Price | TOTAL |
|--|------|--------------------|------------|--------|
| 15" Standard Rootwell Pro 318D aeration sleeve | 132 | Seiber Engineering | 6.50 | 858.00 |



cityofnovi.org

CITY OF NOVI
2011 SPRING LANDSCAPE PLANTING

OFFICIAL BID FORM
BID #3: M-5 Median Tree Plantings (Subject to MDOT Specifications)

All trees 2.5 inch caliper unless specified otherwise.
Trees must be single stemmed tree-form unless requested otherwise by the City.
All work will be in the median of M-5 between Twelve and Fourteen Mile Roads.
City staff will stake all plant installation locations prior to planting.

| Acceptable species of Plant Material | # of Trees | Source /Phone # | Unit Price (1 Yr.) | TOTAL | Unit Price (2 Yr.) | TOTAL ALT. A |
|--|------------|------------------------|--------------------|------------------|--------------------|------------------|
| Acer campestre (Hedge Maple) | 15 | R.C. Tuttle Baldwin | 235.00 | 3,525.00 | 250.00 | 3,750.00 |
| Acer saccharum 'Green Mountain' (Green Mountain Sugar Maple) | 7 | '' | 230.00 | 1,610.00 | 245.00 | 1,715.00 |
| Aesculus hippocastanum 'Ruby Red' (Ruby Red Horsechestnut) | 11 | '' | 275.00 | 3,025.00 | 290.00 | 3,190.00 |
| Amelanchier x grandifolia 'Autumn Brilliance' (Autumn Brilliance Serviceberry) Multi-stem 8' -10' ht | 15 | '' | 225.00 | 3,375.00 | 240.00 | 3,600.00 |
| Crataegus phaenopyrum (Washington Hawthorn) 2" caliper Thornless | 15 | '' | 235.00 | 3,525.00 | 250.00 | 3,750.00 |
| Ginkgo Biloba 'Magyar' (Magyar Ginkgo) | 11 | '' | 250.00 | 2,750.00 | 265.00 | 2,915.00 |
| Malus sp. 'Indian Magic' (Indian Magic Crabapple) 2" Caliper | 25 | '' | 210.00 | 5,250.00 | 225.00 | 5,625.00 |
| Malus sp. 'Red Jewel' (Red Jewel Crabapple) 2" Caliper | 25 | '' | 210.00 | 5,250.00 | 225.00 | 5,625.00 |
| Picea pungens (Blue Spruce) 6'-8' ht | 21 | '' | 165.00 | 3,465.00 | 180.00 | 3,780.00 |
| Pinus nigra (Austrian Pine) 6'-8' ht | 21 | '' | 175.00 | 3,675.00 | 190.00 | 3,990.00 |
| Pyrus calleryana 'Aristocrat' (Aristocrat Pear) | 17 | '' | 210.00 | 3,570.00 | 225.00 | 3,825.00 |
| Quercus rubra (Red Oak) | 11 | '' | 235.00 | 2,585.00 | 250.00 | 2,750.00 |
| ULMUS Americana 'Valley Forge' (Valley Forge American Elm) | 11 | '' | 235.00 | 2,585.00 | 250.00 | 2,750.00 |
| TOTAL | 205 | '' | | 44,190.00 | | 47,265.00 |

| Alternate B | Qty. | Source /Phone # | Unit Price | TOTAL |
|---|------|--------------------|------------|----------|
| 15" Standard Rootwell Pro 318D aeration sleeve (4 per tree) | 820 | Seiber Engineering | 6.50 | 5,330.00 |

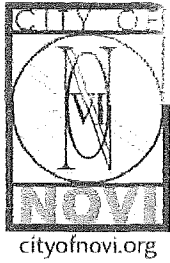

CITY OF NOVI
2011 SPRING LANDSCAPE PLANTING
OFFICIAL BID FORM (REVISED)

BID #4: Brookfarm Park Tree Planting

All trees 2.5 inch caliper unless specified otherwise.

All work will take place on the Brookfarm Park grounds. All trees will be part of a City Arbor Day function. All tree pits will be dug on Friday, May 6, 2011. Trees shall be placed in the plant pits. Final planting operations will be completed by City residents under the supervision of City Staff. City staff will stake all plant installation locations.

| Acceptable species of Plant Material | # of Trees | Source /Phone # | Unit Price (no warranty) | TOTAL |
|--|------------|--------------------------|--------------------------|----------|
| Acer rubrum (Red Maple) | 5 | R.C. Tuttle / Baldwin | 175.00 | 875.00 |
| Platanus x acerifolia (London Plane Tree) | 5 | 11 | 175.00 | 875.00 |
| Tsuga canadensis (Hemlock) | 5 | 11 | 185.00 | 925.00 |
| TOTAL | 15 | | | 2,675.00 |

| Alternate B | Qty. | Source /Phone # | Unit Price | TOTAL |
|---|------|--------------------|------------|--------|
| 15" Standard Rootwell Pro 318D aeration sleeve (4 per tree) | 60 | Seiber Engineering | 6.50 | 390.00 |



CITY OF NOVI
2011 SPRING LANDSCAPE PLANTING

OFFICIAL BID FORM
BID #5: Civic Center Perennial Planting

*All perennials minimum 2 gallon containers unless specified otherwise.
All work will take place on the Civic Center grounds.
City staff will stake all plant installation locations prior to planting.*

| Acceptable species of Plant Material | # of Plants | Source /Phone # | Unit Price (1 Yr.) | TOTAL |
|---|-------------|-----------------|--------------------|---------|
| Echinops ritro (Globe Thistle) | 9 | | 14 | 126.00 |
| Geranium 'Tiny Monster' (Tiny Monster Geranium) | 30 | | 15 | 450.00 |
| Helianthus maximilliani (Maximillion Sunflower) | 9 | | 14 | 126.00 |
| Hibiscus moscheutos 'Blue River' (Blue River Hibiscus) | 5 | | 25 | 125.00 |
| Hibiscus moscheutos 'Disco Bell' (Disco Bell Hibiscus) | 5 | | 25 | 125.00 |
| Hibiscus moscheutos 'Ranier Red' (Ranier Red Hibiscus) | 5 | | 25 | 125.00 |
| Hosta sp. 'Empress Wu' (Empress Wu Hosta) | 10 | | 19 | 190.00 |
| Oenothera missouriensis (Missouri Evening Primrose) | 25 | | 14 | 350.00 |
| TOTAL | 98 | | | 1617.00 |



**CITY OF NOVI
2011 SPRING LANDSCAPE PLANTING**

**OFFICIAL BID FORM
BID #6: Wayfinding Signs Perennial Planting – 6 total**

**All perennials minimum 2 gallon containers unless specified otherwise.
All work will take place on the Civic Center grounds.
Refer to details for bed layout and locations.**

| Acceptable species of Plant Material | # of Plants | Source /Phone # | Unit Price (1 Yr.) | TOTAL |
|--|-------------|-----------------|--------------------|------------|
| Panicum virgatum 'Rotstrahlbusch' (Rotstrahlbusch Switch Grass) | 9 | | 20 | 180 |
| Sedum spurium 'Dragon's Blood' (Dragon's Blood Sedum) | 27 | | 20 | 540 |
| TOTAL for all 6 beds | 36 | | | 720 |

| Acceptable Edging Material | Total Quantity (all 6 beds) * | Source /Phone # | Unit Price | TOTAL |
|---|-------------------------------|-----------------|------------|--------|
| Permaloc Proslide Landscape Edging – 3/16" x 5.5" Black Anodized | 150 LF | | 6.00 | 900.00 |
| Or, City Approved Edging Equivalent, please specify: | LF | | | |

* Contractor is to measure and provide quantity of edging needed based on drawing submitted with bid documents.



**CITY OF NOVI
2011 SPRING LANDSCAPE PLANTING**

**OFFICIAL BID FORM
BID #7: Welcome Signs - 6 total**

**All perennials minimum 2 gallon containers unless specified otherwise.
All work will take place on the Civic Center grounds.
Refer to detail for bed preparation requirements.**

| Acceptable species of Plant Material | # of Plants | Source /Phone # | Unit Price (1 Yr.) | TOTAL |
|--|-------------|-----------------|--------------------|----------------|
| Ceratostigma plumbaginoides (Plumbago) | 57 | | 17.00 | 969.00 |
| Juniperus chinensis 'Skyrocket' (Skyrocket Juniper) | 30 | | 64.00 | 1920.00 |
| Sedum spurium 'Dragon's Blood' (Dragon's Blood Sedum) | 57 | | 17.00 | 969.00 |
| TOTAL for all 6 beds | 144 | | | 3858.00 |

| Acceptable Edging Material | Total Quantity - all 6 beds * | Source /Phone # | Unit Price | TOTAL |
|---|-------------------------------|-----------------|------------|---------|
| Permaloc Proslide Landscape Edging - 3/16" x 5.5" Black Anodized | 270 LF | | 6.00 | 1620.00 |
| Or, City Approved Edging Equivalent, please specify: | LF | | | |
| 24" - 30" Natural Stone Boulders (single welcome sign location retaining wall) | 3 Ton | | 100 | 300.00 |

* Contractor is to measure and provide quantity of edging & boulders needed for beds based on drawing submitted with bid documents.

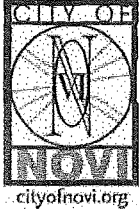

CITY OF NOVI
2011 SPRING LANDSCAPE PLANTING

OFFICIAL BID FORM
BID #8: Provision of Shrubs

Shrubs are to be delivered to the City of Novi Department of Public Services Complex.

| Acceptable species of Plant Material | # of Plants | Source /Phone # | Unit Price | TOTAL |
|---|-------------|-----------------|------------|--------|
| Chaenomeles japonica 'Texas Scarlet' (Texas Scarlet Quince) | 3 | | 25.00 | 75.00 |
| Miscanthus sinensis 'Morning Light' (Morning light Maiden Grass) | 5 | | 16.00 | 80.00 |
| Juniperus chinensis 'Sea Green' (Sea Green Juniper) | 8 | | 20.00 | 160.00 |
| Viburnum opulus 'Compactum' (Compact European Cranberrybush) | 3 | | 24.00 | 72.00 |
| TOTALS | 19 | | | 387.00 |



CITY OF NOVI
2011 SPRING LANDSCAPE PLANTING

MEMORANDUM OF UNDERSTANDING

This organization shall plant trees and perennials, and provide shrubs as specified and accept all terms and conditions of the 2011 landscape planting specifications.

Company Name RC Tuttle

Representative Robert D Sopsich U.P.

Representative Signature R D S

Telephone 248-361-1815

Date 3-26-11

NOTE: The above plant list is for the Contractor's information only, and no guarantee is expressed or implied that quantities therein are correct or that the list is complete.



CITY OF NOVI

2011 SPRING LANDSCAPE PLANTING

LANDSCAPE PLANTING QUESTIONNAIRE FORM

Firm Name: R.C. Tuttle Refinishing Co.

Address: 2475 S. Hickory Ridge Tr.

City: Milford State: MI Zip: 48380

Telephone Number: 248-361-1815 Fax Number: 248-685-9157

Email Address: _____

Firm Established: 1980 Years in Business: 32

Type of Organization: (please circle)

- a. Individual b. Partnership **c. Corporation** d. Joint Venture e. Other _____

How many full time employees? 4 How many part time employees? 7

Provide information relative to the experience your company has had working with municipalities. Please provide the names of municipalities where service was provided.

Huron Clinton Metro Parks. Tim Phillips 810-227-2757

City of Livonia. Chris Pargoff 734-323-4628

City of Riverview. 14100 Civic Park Dr. Riverview, MI 48193.

Purchasing 734-281-4200

Provide information relative to the experience and financial capability of your company to carry out the terms of this contract.

We are a licensed nursery grower in the State of Michigan,
license number NGE 4003238. Dun and Brad Street

Identify those in your firm who would be responsible, including on-site supervision for this project, and submit copies of their certifications. Include educational background of principals and those who will be working on the project.

Robert and Donald Sopsich will be responsible for the
on-site supervision. Been working on similar planting projects
for MDT for the last eight years.

How many clients does your company currently serve with the type of services described? Provide a list.

- Wade Trim Associates, Inc Dan Brooks
- West Bay Exploration
- Flagstar Bank
- Johnson Controls

Please provide a list of client references (minimum of 3) for projects similar in scope to this project, **other than the City of Novi**. Include name, address, phone number and contact person. Please include any municipalities (or other governmental agencies) that you worked for.

- Huron Clinton Metro Parks. Tim Phillips 810-227-2757
- City of Livonia. Chris Pargoff 734-323-4628
- City of Riverview. Purchasing 734-281-4200
- City of Dearborn Heights. Dan Brooks 313-701-0032

Please identify which professional organizations your company is a good standing member of: (please check all that apply)

- International Society of Arboriculture Tree Care Industry Association
- Arboricultural Society of Michigan Michigan Green Industry Association

Provide an Equipment List that for equipment will be on site and available for use by the crew performing tree planting, including skid loaders, trucks, tractors, trailers, etc. Include additional sheet if necessary.

- Four trucks, three skid loaders, two tractors, and seven trailers.

Based on your current resources, are you available to plant the quantity of plant material identified within the timeframe allocated? Please explain.

- Yes. We have enough man power, equipment, and experience to do so.

Provide a description of your company's philosophy relative to tree/shrub planting.

Being a family run company and licensed nursery grower, we take pride in the quality of our stock and work from seedlings to final acceptance of the customer.

THE FOREGOING QUESTIONNAIRE IS A TRUE STATEMENT OF FACTS:

Authorized Company Representative (please print): Robert Sepsick U.P
Representative Signature: 
Date 3-26-11



March 29, 2011

City of Novi
45175 West Ten Mile Road
Novi, MI 48375

RE: R. C. Tuttle Refinishing Company
2475 S. Hickory Ridge Trail
Milford, MI 48380

Pertaining to: 2011 Spring Landscape Planting

To Whom It May Concern:

We are the bonding agent for R. C. Tuttle Refinishing Company. We have full confidence in this firm and their abilities, and we have them currently established with Western Surety Company, an A rated bonding company licensed to do business in Michigan.

We continue to be confident in this company's ability to perform and we recommend them for your favorable consideration. On behalf of Western Surety Company, we wish to state that should they be low bidder on this project and be awarded the contract, we can certainly furnish the performance and payment bonds using the specific language & format of the bonds included with the bid documents provided by the City of Novi, in the face amount of their bid.

This letter is offered as an indication of our past experience and the bonding company's support. Any request for a specific bond(s) will be underwritten on its own merits and subject to the bonding company's underwriting.

Sincerely,



Christina M. Serra, Attorney-In-Fact
Western Surety Company



**NOTICE - CITY OF NOVI
REQUEST FOR BIDS**

2011 SPRING LANDSCAPE PLANTING

The City of Novi will receive sealed bids for **2011 Spring Landscape Planting** according to the specifications of the City of Novi.

A mandatory pre-bid meeting will be held **Wednesday, March 16, 2011 promptly at 10:00 a.m.** at the Novi Civic Center, 45175 W. Ten Mile Rd., Novi, MI 48375-3024.

Sealed bids will be received until **11:00 a.m.** prevailing Eastern Time **Wednesday, March 30, 2011** at which time proposals will be opened and read. Bids shall be addressed to and delivered to:

CITY OF NOVI
CITY CLERK'S OFFICE
45175 W. Ten Mile Rd.
Novi, MI 48375-3024

OUTSIDE OF MAILING/FED EX/UPS ENVELOPES MUST BEAR THE NAME OF THE BIDDING FIRM AND MUST BE PLAINLY MARKED:

"2011 SPRING LANDSCAPE PLANTING BID"

The City reserves the right to accept any or all alternative proposals and award the contract to other than the lowest bidder, to subdivide the award, to waive any irregularities or informalities or both; to reject any or all proposals; and in general to make the award of the contract in any manner deemed by the City, in its sole discretion, to be in the best interest of the City of Novi.

Sue Morianti
Purchasing Manager

Notice dated: March 7, 2011

NOTICE TO BIDDERS:

The City of Novi officially distributes bid documents through the Michigan Intergovernmental Trade Network (MITN). **Copies of bid documents obtained from any other source are not considered official copies.** The City of Novi cannot guarantee the accuracy of any information not obtained from the MITN website and is not responsible for any errors contained by any information received from alternate sources. Only those vendors who obtain bid documents from the MITN system are guaranteed access to receive addendum information, if such information is issued. If you obtained this document from a source other than the source indicated, it is recommended that you register on the MITN site, www.mitn.info, and obtain an official copy.

TYPE OF CONTRACT

If a contract is executed as a result of the quotation, it stipulates a fixed price for products and services.

CONTRACT AWARD

The contract will be awarded to that responsible, responsive bidder whose bid, conforming to this solicitation, will be most advantageous to the City of Novi. Qualifications, experience, references, comparable projects, price, previous experience with vendor/contractor, delivery, and other factors will be considered in the evaluation process and award of contract. The City reserves the right to accept any or all alternative bids and award the contract to other than the lowest bidder, to waive any irregularities or informalities or both; to reject any or all bids; and in general to make the award of the contract in any manner deemed by the City, in its sole discretion, to be in the best interest of the City of Novi.

After contract award, a summary of total price information for all submissions will be posted on the MITN website at www.mitn.info .

INSURANCE

A certificate of insurance naming the City of Novi as an additional insured must be provided by the successful bidder prior to commencement of work. A current certificate of insurance meeting the requirements in Attachment A is to be provided to the City and remain in force during the entire contract period.

CHANGES TO THE BID/ADDENDA

Should any prospective Bidder be in doubt as to the true meaning of any portion of the ITB, or should the Bidder find any patent ambiguity, inconsistency, or omission therein, the Bidder shall make a written request (via email) for official interpretation or correction. Such request shall be submitted to the staff member indicated above. The individual making the request shall be held responsible for its prompt delivery.

Such interpretation or correction, as well as any additional Bid provisions that the City may decide to include, will be made as an addendum, which will be posted on the MITN website at www.mitn.info . Any addendum issued by the City shall become part of the ITB and subsequent contract and shall be taken into account by each bidder in preparing its bid. Only written addenda are binding. It is the Bidder's responsibility to be sure they have obtained all addenda. Receipt of all addenda must be acknowledged on bid form.

RESPONSE DATE

To be considered, sealed proposals must arrive at the specified location by the specified time. There will be no exceptions to this requirement. The City of Novi shall not be held responsible for lost or misdirected proposals.

Contractors mailing proposals should allow ample time to ensure the timely delivery of their proposals. All proposals must be contained in sealed envelopes marked on the outside with the contractor's name and the name of the bid. Proposals received after the closing date and time will not be accepted or considered. Telegraphic, facsimile, or telephone proposals are not acceptable.

SUBMISSION OF BIDS

Bids must be submitted in a sealed envelope. Outside of mailing envelope must be labeled with name of contractor and name of bid. Failure to do so may result in a premature opening or failure to open such proposal.

To be considered, sealed bids must arrive at the Clerk's Office, on or before the specified time and date. There will be no exceptions to this requirement. Contractors mailing bids should allow ample time to ensure the timely delivery of their bid. Bids received after the closing date and time will not be accepted or considered. Faxed, emailed, or telephone bids are not acceptable. The City of Novi shall not be held responsible for lost or misdirected bids.

Bids must be clearly prepared and legible and must be signed by an Officer of the submitting Company on the enclosed form. **Bids must show unit, extended pricing and totals if requested.** In case of mistakes in price extension, the unit price shall govern. ANY CHANGES MADE ON BID FORMS MUST BE INITIALED OR YOUR BID MAY BE CONSIDERED NON-RESPONSIVE. Failure to include in the bid all information requested may be cause for rejection of the bid.

A bid may be withdrawn by giving written notice to the Purchasing Manager before the stated due date/closing time. After the stated closing time, the bid may not be withdrawn or canceled for a period of One Hundred and Twenty (120) days from closing time.

No proposal will be accepted from, or contract awarded to any person, firm, or corporation that is in arrears or is in default to the City Novi upon any debt or contract, or that is in default as surety or otherwise, or failed to perform faithfully any previous contract with the City.

FREIGHT/SHIPPING/DELIVERY CHARGES

Proposal pricing must contain all shipping/handling/delivery charges.

TAX EXEMPTION

It is understood that the City of Novi is a governmental unit, and as such, is exempt from the payment of all Michigan State Sales and Federal Excise taxes. Do not include such taxes in the bid prices. The City will furnish the successful bidder with tax exemption certificates when requested. The City's tax-exempt number is 38-6032551.

TRANSFER OF CONTRACT/SUBCONTRACTING

The successful bidder will be prohibited from assigning, transferring, converting or otherwise disposing of the contract agreement to any other person, company or corporation without the expressed written consent of the City of Novi. Such approval shall not constitute a basis for privity between the City and any subcontractor. Any subcontractor, so approved, shall be bound by the terms and conditions of the contract. The contractor shall be fully liable for all acts and omissions of its subcontractor(s) and shall indemnify the City of Novi for such acts or omissions.

CONTRACT TERMINATION

The City may terminate and/or cancel this contract (or any part thereof) at any time during the term, any renewal, or any extension of this contract, upon thirty days (30) days written notice to the Contractor, for any reason, including convenience without incurring obligation or penalty of any kind. The effective date for termination or cancellation shall be clearly stated in the written notice.

NON-DISCRIMINATION

In the hiring of employees for the performance of work described in this ITB and subsequent contract, neither the contractor, subcontractor, nor any person acting in their behalf shall by reason of religion, race, color, national origin, age, sex, height, weight, handicap, ancestry, place of birth, sexual preference or marital status discriminate against any person qualified to perform the work required in the execution of the contract.

ACCEPTANCE OF PROPOSAL CONTENT

Should a contract ensue, the contents of the proposal of the successful Bidder may become contractual obligations. Failure of a contractor to accept these obligations may result in cancellation of the award.

MATERIAL SUBMITTED

All documents, specifications, and correspondence submitted to the City of Novi become the property of the City of Novi and are subject to disclosure under the provisions of Public Act No. 442 of 1976 known as the "Freedom of Information Act". This Act also provides for the complete disclosure of contracts and attachments hereto. This means that any informational material submitted as part of this RFP is available without redaction to any individual or organization upon request.

INCURRING COSTS

The City of Novi is not liable for any costs incurred by bidders prior to issuance of a contract.

ECONOMY OF PREPARATION

Proposals should be prepared simply and economically, providing a straightforward and concise description of the contractor's ability to meet the requirements of the bid. Emphasis should be on completeness and clarity of content. Included in the response must be a point by point response to the Requirements and other sections of the bid.

DISCLOSURE OF PROPOSAL CONTENT

After contract award, and upon written request, a summary of total price information for all submissions will be furnished to those contractors participating in this bid.

INDEPENDENT PRICE DETERMINATIONS

By submission of a proposal, the offerer certifies, and in case of a joint proposal, each party hereto certifies as to its own organization, that in connection with the proposal:

- (a) The prices in the proposal have been arrived at independently without consultation, communication, or agreement, for the purpose of restricting competition, as to any matter relating to such prices with any other offerer or with any other Competitor; and
- (b) No attempt has been made or will be made by the offerer to induce any other person or firm to submit or not submit a proposal for the purpose of restricting competition.

Each person signing the proposal certifies that:

- (c) He is the person in the offerer's organization responsible within that organization for the decision as to prices being offered in the proposal and that he has not participated and will not participate in any action contrary to (a) and (b) above; or
- (d) He is not the person in the offerer's organization responsible within that organization for the decision as to prices being offered in the proposal but that he has been authorized in writing to act as agent for the persons responsible for such decisions in verifying that

such persons have not participated, and will not participate, in any action contrary to (a) and (b) above , and that as their agent, does hereby so certify; and that he has not participated, and will not participate in any action contrary to (a) and (b) above.

A proposal will not be considered for award if the sense of the statements required in the proposal has been altered so as to delete or modify the above.



CITY OF NOVI

2011 SPRING LANDSCAPE PLANTING

1. Purpose/Scope of Work

The City of Novi is soliciting seven (7) bids for the 2011 landscape plantings. All bids are for the purchase, installation, and warranty by the bidding contractor. The City is also soliciting one (1) bid for materials only.

- **BID 1: Subdivision Tree Plantings**
 - **Alternate B** - 15" Standard Rootwell Pro 318D aeration sleeve (4 per tree)
- **BID 2: Fuerst Park Tree Plantings**
 - **Alternate B** - 15" Standard Rootwell Pro 318D aeration sleeve (4 per tree)
- **BID 3: M-5 Median Tree Plantings**
 - **Alternate B** - 15" Standard Rootwell Pro 318D aeration sleeve (4 per tree)
- **BID 4: Brookfarm Tree Plantings**
 - **Alternate B** - 15" Standard Rootwell Pro 318D aeration sleeve (4 per tree)
- **BID 5: Civic Center Perennial Plantings**
- **BID 6: Wayfinding Sign Perennial Plantings**
- **BID 7: Welcome Sign Perennial Plantings**
- **BID 8: Provision of Shrubs – no installation required**

ALL BIDS SHALL BE SUBMITTED ON SUPPLIED OFFICIAL BID FORMS. All bids shall be quoted on a per unit basis. Any bids not so submitted will be disqualified. It is the intent of the City to utilize one contractor; however we reserve the right to enter into more than one contract. If you are unable to provide the specified quantity of plant material, please indicate by changing the number on the bid forms where appropriate. Bids shall include all material, labor, equipment, and warranty costs.

2. Applicable Specifications and Standards

- A. *Principles and Practice of Planting Trees and Shrubs*. 1997. International Society of Arboriculture, P.O. Box GG, Savoy, IL 61874
- B. *American Standard for Nursery Stock*. 1996. American Association of Nurserymen, Inc., 1250 I Street, N.C Suite 500, Washington, D.C. 20005
- C. *Standardized Plant Names*. 1942. American Joint Committee on Horticulture Nomenclature, Horace McFarland Company, Harrisburg, Pennsylvania. (Second Edition)

- D. *City of Novi Landscape Design Manual*. 2003. City Council, 45175 W. Ten Mile Road, Novi, MI 48375

3. Planting/Project Season

- A. This project shall be completed within the following dates:

All Bids: April 19, 2011 to June 10, 2011.

- B. Variance: If special conditions exist that warrant a variance in the above planting dates, a written request shall be submitted to Parks and Forestry Asset Manager and/or City Landscape Architect stating the special conditions and the proposed variance. The variance will be granted if warranted in the opinion of the Parks and Forestry Asset Manager or City Landscape Architect.

4. General Specifications

- A. Permissible working hours are 7:30 A.M. to 4:00 P.M., Monday through Friday unless otherwise authorized by the City. The Contractor shall notify the City of intended operations prior to commencement of work on each working day. No weekend or holiday work will be permitted unless prior authorization is granted by the City. At the end of each working day, the contractor shall clean all work sites of all rubbish, debris, and trimmings resulting from the work, and all work locations shall be left in a neat, safe, and presentable condition.
- B. Planting shall commence no later than twenty (30) days after the contract has been awarded. Failure to comply may result in termination of this contract.
- C. Contractor shall be responsible for any damage to utilities during the planting process.
- D. Contractor shall be responsible for all associated fees that may be required for this project (Road Commission for Oakland County permit fees, MDOT permit fees, bonds...).
- E. All persons doing work on this project shall be properly uniformed. Contractor's employees shall maintain a neat and clean appearance at all times. Employees shall wear the appropriate clothing apparel at all times. All work shall be performed in a professional and courteous manner.
- F. All vehicles performing work on this project shall be properly placarded with the Contractor's name identified. Contractor's equipment shall have neat and clean appearance at all times.
- G. All crews shall be supervised at all times by the Contractor.
- H. Contractor's equipment and general safety practices must meet all OSHA and MIOSHA requirements.
- I. At no time shall the contractor leave open planting holes unfilled with either soil or plant material at the end of the work day. All rubbish, debris, excess soil, sod, trimmings, etc., generated in the performance of this contract shall be properly disposed of off-site by the contractor. All work shall be subject to the direct supervision of the Forestry Division and/or Community Development Department, and in all respects shall meet with the City's approval as conforming with the provisions and requirement of this contract.
- J. During the progress of work, adequate provisions shall be made by the contractor to accommodate normal traffic flow over the public streets so as to cause a minimum of inconvenience to the general public. Means of ingress and egress for occupants of property adjacent to the work, with convenient access to driveways, housing, or building shall be provided to the maximum possible extent.
- K. The contractor will be required to provide and maintain any and all safety devices, such as barriers, guards, and lights, when and where it may be necessary to do as a result of the work being done. Such devices, barriers, markings, signs, or traffic lights shall conform to the current Michigan Manual of Uniform Traffic Control Devices.
- L. The contractor will be held responsible for the preservation of all public and private property along and adjacent to the work area, and will be required to exercise due care to avoid and

- prevent any damage or injury as a consequence of his work. All turf, trees, shrubs, ground covers, fences, irrigations systems and utilities shall be adequately protected.
- M. Should any direct or indirect damage or injury result to any public or private property by or on account of any act, omission, neglect, or conduct in the execution of the work or as a consequence of the execution or non-execution thereof on the parts of the Contractor such as property shall be restored, by and at the expense of the Contractor, to a condition equivalent to that existing before the damage or injury occurred, by repairing or rebuilding the same or by otherwise making good such damage or injury in a manner acceptable to the City.
 - N. Public Relations: For all street tree plantings an informational door hanger will be distributed by the City to adjacent property owners prior to commencement of the project.
 - O. All work must be completed to the satisfaction of the Parks and Forestry Asset Manager, or his/her representative and any questions as to proper procedures or quality of workmanship will be resolved by the same. The Contractor shall be required to address all City requests as they pertain to this contract. Failure to immediately and appropriately address such issues as determined by the City may result in termination of this contract. A City Representative will inspect the work performed by the contractor to ensure the completion of the planting in accordance with these specifications. Should more than two inspections be required on plant material and/or landscape beds needing additional work, the contractor may be billed for City staff time.
 - P. The City and Contractor shall meet at least once a week to discuss the results of the City's inspection/progress reports. Failure to immediately and appropriately address such issues may result in termination of this contract.

5. Planting Locations

- A. The Contractor shall plant at locations to be determined and marked by the Parks and Forestry Asset Manager, City Landscape Architect, or their designee.
- B. The Parks and Forestry Asset Manager and/or City Landscape Architect will supply locations for individual trees/shrubs. The location may be inferred from reference to some identifiable field object or from some line that can be constructed in the field.
- C. No tree shall be planted within 15 lateral feet of overhead utility wires.
- D. No tree shall be planted within 10 ft. of fire hydrants, driveways, streetlights and 35 ft. of intersections, or as specified by local ordinance.
- E. No tree/shrub shall be planted closer than 6' to adjacent curb or road edge unless directed by the City.

6. Utility Verification

- A. **The Contractor shall contact Miss-Dig for verification of the location of all underground utilities in the area of the work and the Contractor shall not commence digging until all underground utilities have been marked.** The Contractor shall be responsible for all damage resulting from neglect or failure to comply with this requirement and/or for all damages to marked underground utilities.

7. Materials

- A. Topsoil will be furnished by the contractor to the site. The topsoil shall be declared by the Contractor to be free from subsoil, roots, stones over 1 inch in (2.5 cm) in diameter, herbicides, contaminants, and other extraneous materials. The Contractor shall dispose of all excavated materials. Topsoil shall be of granular structure, less than 27 percent clay, and 4 to 5 percent organic matter by weight. Topsoil shall not be used in a frozen or muddy condition. The Contractor shall remove all surplus materials.
- B. Compost shall consist of finely divided or granular texture composed of decomposed organic materials.

- C. Mulch: Unless otherwise noted, all mulch shall be Grade A, true 100 percent double-shredded product. It shall be of hardwood (either Maple or Oak) with no more than 10% by-product. Wood-chips and sticks are not acceptable.
- D. Substitutions: When a contractor submits their bid, it is assumed they know where to obtain all specified plant materials. Other plant materials of similar characteristics may be accepted with written permission of the City. Proof must be submitted that material specified is not obtainable.
- E. Plants shall be true to species, variety specified, and nursery grown in accordance with good horticultural practices under climatic conditions similar to those in the locality of the project for at least 2 years. Plants of a northern seed source may be used if approved by the Parks and Forestry Asset Manager and/or Landscape Architect. They shall have been freshly dug (during the most recent favorable harvest season).

Unless specifically noted, all plants shall be of specimen quality, exceptionally heavy, symmetrical, so trained or favored in development and appearance to be unquestionably and outstandingly superior in form, compactness, and symmetry. They shall be sound, healthy, vigorous, well branched and densely foliated when in leaf; free of disease and insects, eggs, or larvae; and shall have healthy, well-developed root systems. They shall be free from physical damage or other conditions that would prevent vigorous growth.

Trees with multiple leaders, unless specified, will be rejected. Plant material with a damaged or crooked leader, bark abrasions, sunscald, disfiguring knots, insect damage, or cuts of limbs over $\frac{3}{4}$ in (2cm) in diameter that are not completely closed will be rejected.

- **All trees shall be no less than 2.5-inch caliper unless otherwise specified.**

Plants shall conform to the measurements specified, except that plants larger than those specified might be used if approved by the Parks and Forestry Asset Manager and/or Landscape Architect. Use of larger plants shall not increase the contract price. If larger plants are approved, the root ball shall be increased in proportion to the size of the plant as specified in the *Principles and Practice of Planting Trees and Shrubs*.

Caliper measurements shall be taken on the trunk 6 inches (15cm) above the natural ground line for trees up to and including 4 inches (10 cm) in caliper, and 12 inches (30 cm) above the natural ground line for trees over 4 inches (10 cm) in caliper. Height and spread dimensions specified refer to the main body of the plant and not from branch tip to branch tip. No "whips" shall be planted. Plants shall be measured when branches are in their position. If a range of a size is given, no plant shall be less than the minimum size, and less than 50 percent of the plants shall be as large as the maximum size specified. Measurements specified are minimum size acceptable after pruning, where pruning is required. Plants that meet measurements but do not possess a standard relationship between height and spread, according to the American Standards for Nursery Stock, shall be rejected.

- F. The plant list at the end of this section is for the Contractor's information only, no guarantee is expressed or implied that quantities therein are correct or that the list is complete. The Contractor shall satisfy himself that all plant materials shown on the drawings are included in his bid.
- G. All plants shall be labeled by plant name and size. Labels shall be attached securely to all plants, bundles, and containers of plant materials when delivered. Plant labels shall be durable and legible, with information given in weather-resistant ink or embossed process lettering.
- H. **Certificates of Plant Inspections:** Certificates of inspection shall accompany invoices for each shipment of plants as may be required by law for transportation. Certificates are to be filed with the Parks and Forestry Asset Manager and/or City Landscape Architect prior to acceptance of the material. Passing inspection by federal or state governments at place of growth does not preclude rejection of plants at the work site.

8. Selection and Tagging

- A. Plants shall be subject to inspection for conformity to specification requirements and approval by the Parks and Forestry Asset Manager and/or City Landscape Architect prior to delivery. The Parks and Forestry Asset Manager and/or City Landscape Architect shall tag all plant material to be used for this project and reject any plant material that they feel does not meet quality standards. Such approval shall not impair the right of inspection and rejection during progress of the work. A Contractor's representative shall be present at all inspections.
- B. Plants shall be subject to inspection and approval by the Parks and Forestry Asset Manager and/or City Landscape Architect (at their discretion) at their place of growth. Travel expenses (maximum \$800 per staff member) related to inspections will be billed directly to the contractor.

9. Excavation of Planted Areas

- A. Locations for plants and outlines of area to be planted will be identified via marking paint or flagging at the site by the City. Approval of the Parks and Forestry Asset Manager and/or City Landscape Architect may be required before excavation begins.
- B. Detrimental soil conditions: The Parks and Forestry Asset Manager and/or City Landscape Architect are to be notified, in writing, of soil conditions that the Contractor considers detrimental to the growth of plant material. These conditions are to be described as well as suggestions for correcting them. Proper water drainage shall be assured.
- C. Contractor shall repair any broken sprinkler within 24 hours of any damage. Contractor will carry ten (10) couplers and twenty (20) hose clamps and five (5) feet of ¾ and 1-inch pipe at all times.
- D. Contractor shall restore, to satisfaction of the Parks and Forestry Asset Manager and/or City Landscape Architect, any damage done to adjacent planting site areas.
- E. Obstructions: if rock, underground construction work, tree roots, or obstructions are encountered in the excavation of plant pits, the Parks and Forestry Asset Manager and/or City Landscape Architect may select alternate locations. Where locations cannot be changed as determined by the Parks and Forestry Asset Manager and/or City Landscape Architect, and where digging is permitted, submit cost required to remove the obstruction to a depth of not less than 6 inches (15 cm) below the required hole depth. Proceed with work after approval of the Parks and Forestry Asset Manager and/or City Landscape Architect.

10. Digging and Handling Plant Materials

- A. Anti-transpirants are to be applied to plants in full leaf immediately before digging. A film shall adequately cover all foliage.
- B. Plant materials designated as B & B shall be properly dug with firm natural balls of soil retaining as many fibrous roots as possible in sizes and shapes as specified in the most recent edition of the *American Standard for Nursery Stock*. Balls shall be firmly wrapped with nonsynthetic, rotatable burlap and secured with nails and heavy, nonsynthetic, and rotatable twine. Root collar will be apparent at surface of ball. No plant material with loose, broken, or manufactured balls will be planted, **except with special written approval before planting.**
- C. Plants grown in containers shall be of appropriate size for the container as specified in the most recent edition of the *American Standard for Nursery Stock*, and be free of circling roots on the exterior and the interior of the root ball.
- D. All other types of nursery stock shall also conform to the *American Standard for Nursery Stock*.

11. Transportation and Storage of Plant Material

- A. Fresh dug material is given preference over plant material held in storage. Plant material held in storage will be rejected if excessive growth or dieback of branches has occurred in storage.
- B. Branches shall be tied with rope or twine only, and in such a manner that no damage will occur to the bark or branches.
- C. During transportation of plant material, the Contractor shall exercise care to prevent injury and drying out of the plant material. Should the roots be dried out, large branches broken, balls of earth broken or loosened, or area of bark torn, the Parks and Forestry Asset Manager and/or City Landscape Architect may reject the injured tree(s) and order them replaced at no additional cost to the City.
- D. Plants must be protected at all times from sun or drying winds. No plant material shall be stored on City Property unless approved by the Parks and Forestry Asset Manager. If approved, the City of Novi shall assume no responsibility for any plant material while stored on City property. Those plants that cannot be planted immediately on delivery shall be kept in the shade, well protected with soil covered with wet wood chips or other acceptable material and kept well watered. Plants shall not remain unplanted any longer than 3 days after delivery. Plants shall not be bound with wire or rope at any time so as to damage the bark or break branches. Plants shall be lifted and handled with suitable support of the soil ball to avoid damaging it.
- E. All trees shall be transplanted and transported with stem guards. Trees with damaged stems will be rejected

12. Planting Operations

- A. All trees/shrub shall be planted in accordance with the tree/shrub planting detail provided.
- B. Width of the planting hole shall be at least 2 – 3 times the width of the rootball. Plants must be set plumb and braced in position until prepared topsoil has been placed around the ball and roots. **Trees and shrubs shall be planted so that the flare of the trunk is 2 inches above preexisting grade.** Plants shall be set so that they will be the same depth 1 year later. The trunk of the tree is not to be used as a lever in positioning or moving the tree in the planting hole.

NOTE: Because some nurseries practice tilling around trees, the root flare may be buried several inches deep. In some cases the top of the root ball may be at ground level, but the root flare actually is too deep. Proper planting depth requires the root flare to be at or slightly above the finished grade. It is important to determine how deep the root flare is in the ball before it is placed in the planting hole. Sometimes the top of the ball may need to be raised until the root flare is at the proper planting depth. Remove the excess soil on the top of the root ball.

- C. Ropes, strings, and wrapping from the top of the root ball are to be removed after the plant has been set. All waterproof or water repellent wrapping shall be removed from the ball. **Remove at least the top half of the wire basket before backfilling.**
- D. Amend the backfill soil by adding 5 percent (by weight, 20-35 percent by volume, depending on materials) composted organic matter. **In heavy clay soils (especially in parks, major roads, interchanges, and other non-residential locations) use soil from the site, composted organic matter and sand in equal volumes.**
- E. Basins are to be formed around tree/shrub root ball with a raised ring of soil as indicated on drawing.
- F. Planting areas are to be finish graded to conform to grades (2-3 inches above preexisting grade) on drawing after full settlement has occurred.

- G. Prior to installing a tree/shrub in a planting hole, the hole shall be filled to 1/2 its depth with water. Water shall remain in the hole until the tree has been backfilled. The Parks and Forestry Asset Manager and/or City Landscape Architect may allow plant material to be thoroughly watered immediately after planting.
- H. Any excess soil, debris, or trimmings shall be removed from the planting site immediately upon completion of each planting operation.
- I. Planting pits shall be at least 24" greater in diameter than the corresponding root ball, and shall have sides fractured in order to facilitate root penetration. Walls of the planting hole shall be dug so that they are properly sloped and sufficiently loosened to remove the glazing effects of digging. Holes shall be ground only on the day the tree is planted. Contractor is responsible to ensure all holes are safe until planted and covered with mulch.

13. **Guying, Staking, Wrapping, Pruning, Mulching, and stump removal**

- A. All trees shall be staked as identified in the attached planting detail. The contractor shall remove stakes after the first growing season. **NO METAL T-STAKES ARE PERMITTED!**
- B. Staking materials: No wire shall be used around any of the trunks of the trees. Diagonal supporting stakes three (3) shall be sound, uniform oak, redwood, or cedar as identified in the provided planting detail.
- C. **Top half of wire baskets shall be removed (after trees have secured in their plantings holes), taken off not folded under,** after base of the root ball has been secured. This shall include binding twine, wire loops, and first row of wire squares
- D. No tree wrap shall be used unless approved by the Parks and Forestry Asset Manager and/or City Landscape Architect.
- E. Plants are to be pruned at the time of planting and according to best horticulture practice. Pruning of all plant material will include the removal of injured branches, double leaders, waterspouts, suckers, and interfering limbs. Healthy lower branches and small twigs close to the center should not be removed, except as necessary to clear sidewalks or streets. All pruning cuts shall be clean and smooth, with the bark intact and uninjured at the edges. In no case shall more than one-third of the branching structure be removed, **leaving the normal shape of the plant intact.** If use of tree paint is specified by the Parks and Forestry Asset Manager and/or City Landscape Architect, it shall be a standard type specifically recommended as tree wound dressing paint.
- F. All trees/shrubs will be mulched with a mixture of shredded wood and bark previously approved by the Parks and Forestry Asset Manager and/or Landscape Architect. The composted mulch will be free of materials injurious to plant growth, branches, leaves, roots, and other extraneous matter. The mulch will be 4 inches deep around trees and shrubs. **NO WOODCHIPS SHALL BE USED ON THIS PROJECT. Mulch must not be placed within 3 inches (8cm) of the trunks of trees/shrubs.**
- G. The contractor shall dispose of any debris (including tree roots, stumps, rocks, soil...) in the planting area.

14. **Landscape Bed Creation and Installation**

- A. The planting and creation of landscape shall follow the standard specifications and design plan.
 - The Parks and Forestry Asset Manager and/or Landscape Architect may elect to outline the bed area prior to installation.
 - The City may alter the design, if desired.
 - The City may add, change, and/or remove the quantities of plant materials and/or bed design as desired.
- B. The contractor is responsible for acquisition and planting of plants per the City's design unless altered by the City.

- C. Each landscape bed shall be edged mechanically or with a spade prior to installation and at least once per year through the duration of this contract.
- D. Contractor shall provide proof of origin for all plan materials (compost, topsoil and mulch). Specifications for these items are identified in the above "Materials" section and/or the planting details provided below.
- E. Existing sod shall be removed prior to installation.
 - The existing underlying soil shall be tilled to a depth 12 inches.
 - 2 inches of compost and 2 inches of topsoil shall be added (to the existing tilled topsoil) and tilled into the bed.

15. Maintenance of Plant Materials and Landscape Beds

- A. Maintenance shall begin immediately after each plant is planted and shall continue throughout the period of this contract.
- B. Maintenance shall include ALL landscape beds created through this contract.
- C. Maintenance shall consist of pruning, watering, fertilization, cultivating (including weeding), mulching, edging, tightening and repairing guys and stakes, resetting plants to proper grades or upright position, restoration of the planting saucer, and furnishing and applying such sprays or other materials as are necessary to keep plantings free of insects and diseases and in vigorous condition.
- D. Planting areas (including landscape beds) and plants shall be protected at all times against damage for the duration of the maintenance period. If a plant becomes damaged or injured, it shall be treated or replaced as directed by the Parks and Forestry Asset Manager and/or City Landscape Architect at no additional cost.
- E. Watering: Contractor shall irrigate, as required, to maintain vigorous and healthy tree growth. **All plants shall be watered at the time of planting unless directed otherwise by the Parks and Forestry Asset Manager and/or City Landscape Architect.** Over-watering or flooding shall not be allowed. Contractor shall use existing irrigation facilities and furnish any additional material, equipment, or water to ensure adequate irrigation. During periods of restricted water usage, all governmental regulations (permanent and temporary) shall be followed. Should modifications of existing irrigation systems and/or schedules facilitate adherence to these regulations, the Contractor shall notify the owner of the suggested modifications.
- F. Fertilization: Fertilizer shall be applied at the time of planting and shall be a controlled-release type formulated for trees and shrubs, and must be approved by the Parks and Forestry Asset Manager and/or City Landscape Architect. The approved fertilizer shall be used at the rate specified by the manufacturer.

16. Contract Termination

The City shall have the right to terminate a contract or part thereof before the work is completed with thirty (30) days written notice:

- A. For Cause:
 - The contractor is not complying with the specifications;
 - Proper arboricultural techniques are not being followed after written notification by the City;
 - The Contractor refuses, neglects, or fails to supply properly trained or skilled personnel, proper equipment, or acceptable plant material;
 - The Contractor in the judgment of the City is unnecessarily or willfully delaying the performance and completion of the work;

- Previous unknown circumstances arise making it desirable in the public interest to void the contract;
- The Contractors fails to comply with the terms of this contract;
- The Contractor refuses to proceed with the work when as directed by the City; or
- The Contractor abandons the work.

Any hazardous practice as determined by the City shall be immediately discontinued by the contractor upon receipt of either verbal or written notice to discontinue such practice.

For Convenience:

The City may terminate the agreement, in whole or in part, without showing cause upon giving thirty (30) days written notice to the Contractor. The City shall pay all reasonable costs incurred by the Client up to the date of notice of termination. The Contractor will not be reimbursed for any anticipatory profits that have not been earned up to the date of notice of termination.

17. Acceptance

The Parks and Forestry Asset Manager and/or City Landscape Architect shall inspect all work for acceptance upon written request for the Contractor. The request shall be received at least 10 calendar days before the anticipated date of inspection.

Acceptance of plant material by the Parks and Forestry Asset Manager and/or City Landscape Architect shall be for general conformance to specified size, character, and quality and shall not relieve the Contractor of responsibility for full conformance to the contract documents, including correct species.

Upon completion and re-inspection of all repairs or renewals necessary in the judgment of the Parks and Forestry Asset Manager and/or City Landscape Architect, the Parks and Forestry Asset Manager and/or City Landscape Architect shall certify in writing that the work has been accepted.

18. Acceptance in Part

Work may be accepted in parts when the Parks and Forestry Asset Manager and/or City Landscape Architect and Contractor deem that practice to be in their mutual interest. The Parks and Forestry Asset Manager and/or City Landscape Architect must give approval in writing to the Contractor verifying that the work is to be completed in parts. Acceptance of work in parts shall not waive any other provision of this contract.

19. Guarantee Period and Replacements

- A. The guarantee period for plant material shall begin at the date of acceptance.
- B. The Contractor shall guarantee all plant material to be in healthy and flourishing condition as determined by the City of Novi for a period of 1 year or 2 years (**depending on Alternate**) from the date of acceptance.
- C. When work is accepted in parts, the guarantee periods extend from each of the partial acceptances to the terminal date of the guarantee of the last acceptance. Thus, **all guarantee periods terminate at one time.**
- D. The Contractor shall replace, without cost, as soon as weather conditions permit, and within a specified planting period, all plants determined by the Parks and Forestry Asset Manager and/or City Landscape Architect to be dead or in an unacceptable condition during and at the end of the guarantee period. To be considered acceptable, plants shall be free of dead or dying branches and branch tips and shall bear foliage of normal density, size, and color. Replacements shall closely

match adjacent specimens of the same species. Replacements shall be subject to all requirements stated in this specification. The City may allow substitutions.

- E. The guarantee of all replacement plants shall extend for an additional period of 1 year beyond the initial warranty period (one year beyond the initial two year warranty period). If a tree dies between the 1 and two year initial warranty period, the warranty on the replacement tree shall extend for a period 1 year after the 2 year initial warranty period has ended. In the event that a replacement plant is not acceptable during or at the end of the said extended guarantee period, the Parks and Forestry Asset Manager and/or City Landscape Architect may elect subsequent replacement or credit for that item.
- F. The Contractor shall make periodic inspections, at no extra cost, during the guarantee period to determine what changes, if any, should be made in the maintenance program. If changes are recommended, they shall be submitted in writing to the Parks and Forestry Asset Manager and/or City Landscape Architect.

20. Final Inspection and Final Acceptance

At the end of the guarantee period and upon written request of the Contractor, the Parks and Forestry Asset Manager and/or City Landscape Architect will inspect all guaranteed work for final acceptance. The request shall be received at least 10 days before the anticipated date for final inspection. Upon completion and re-inspection of all repairs or renewals necessary in the judgment of the Parks and Forestry Asset Manager and/or City Landscape Architect at that time, the Parks and Forestry Asset Manager and/or City Landscape Architect shall certify, in writing, that the project has received final acceptance.

21. Selection Criteria

Proposals will be evaluated and ranked. The City of Novi reserves the right to reject any and all proposals, to make an award based directly on the proposals or to negotiate further with one or more companies. The proposer selected for the award will be chosen on the basis of the apparent greatest benefit to the City, including but not limited to:

A. Experience/Qualifications

Proposals on this contract shall be limited to individuals, partnerships, and corporations actively engaged in landscaping. Proposers shall demonstrate competence, experience, and financial capability to carry out the terms of this contract. The City will require proof of these qualifications and work performance references.

B. Capacity

Proposers should clearly identify all available resources within the company and those that will be subcontracted to others. Provide an Equipment List and number of full-time/part-time employees that will be made available to accomplish the work described in these documents.

C. Comparable Projects

Proposers should submit examples of similar work performed.

D. Timeline

Provide proposed schedule for the performance of the tree planting services, including under unusual or unexpected weather conditions.

E. References

Provide a list of references from comparable projects that have been successfully completed by your company. Include the names of contacts.

F. Cost

Cost Proposals per Official Bid Form.

22. General Conditions

- A. The City of Novi reserves the right to interview any number of qualifying providers as part of the evaluation process. The decision of which provider to contact (if any) will be based on the most qualified, cost effective and experienced provider(s) determined in the evaluation process. The City of Novi reserves the right to select, and subsequently recommend for award, the proposed services which best meets its required needs, quality levels and budget constraints.
- B. The City is not required to accept the lowest proposal in all or in part. The proposal award will not be based solely upon cost, but will be evaluated based upon criteria formulated around the most important features of the services, of which qualifications, experience, capacity and comparable projects may be overriding factors. The proposal evaluation criteria should be viewed as standards, which measure how well a vendor's approach meets the desired requirements and needs of the City.
- C. All proposals shall be opened publicly at the date and time specified. Each shall be recorded with the name of the proposer. All proposals shall be in accordance with the Purchasing Department and the requirements of this notice in order to be deemed "responsive."
- D. No proposal will be accepted from any person, firm or corporation who is in arrears upon any obligation to the City or who otherwise may be deemed irresponsible or unreliable by the City.
- E. No proposal will be allowed to be withdrawn after it has been deposited with the City of Novi, except as provided by law.
- F. Any deviation from the scope of work must be noted in the proposal.
- G. The Request for Proposal document together with its addenda, amendments, attachments and modifications, when executed, becomes the contract or part of the contract between the parties.
- H. Any proposal submitted which requires a down payment or prepayment of any kind prior to work completion and full acceptance as being in conformance to specifications will not be considered for award.

23. Instructions to Contractors

The following pages include a **(1)** vendor questionnaire and **(2)** official bid form. These items must be **FULLY** completed and submitted.

An UNBOUND completed original (marked "Original") and three (3) copies of your questionnaire and official bid form MUST be submitted.

Bidders not responding to any of the specifications or questions may be classified as unresponsive. The response must follow the format outlined in this proposal. Supplemental information may be attached.

24. Payment

Payment shall be made to the Contractor as follows:

- 80 % of the contract sum upon receipt, completion of planting of the plant materials by the contractor, and acceptance of the plant materials by the Parks and Forestry Asset Manager and/or City Landscape Architect.
- 10 % of contract sum after the replanting of replacement material, if required.
- 10 % of contract sum after final acceptance.

NOTE: It is the contractor's responsibility to ensure that all invoices are accurate and detailed. Failure to submit accurate and detailed invoices will result in delayed payment.



**CITY OF NOVI
INSURANCE REQUIREMENTS**

ATTACHMENT A

1. The Contractor shall maintain at its expense during the term of this Contract, the following insurance:
 - a. **Worker's Compensation** insurance with the Michigan statutory limits and Employer's Liability insurance with minimum limits of **\$100,000** (One Hundred Thousand Dollars) each accident.
 - b. **Commercial General Liability Insurance** – The Contractor shall procure and maintain during the life of this contract, Commercial General Liability Insurance, Personal Injury, Bodily Injury and Property Damage on an “Occurrence Basis” with limits of liability not less than **\$1,000,000** (One Million Dollars) per occurrence combined single limit.
 - c. **Automobile Liability** insurance covering all owned, hired and non-owned vehicles with Personal Protection insurance to comply with the provisions of the Michigan No Fault Insurance Law including Residual Liability insurance with minimum bodily injury limits of **\$1,000,000** (One Million Dollars) each person and **\$1,000,000** (One Million Dollars) each occurrence and minimum property damage limits of **\$1,000,000** (One Million Dollars) each occurrence.
2. All policies shall name the Contractor as the insured and shall be accompanied by a commitment from the insurer that such policies shall not be canceled or reduced without at least thirty (30) days prior notice date to the City.
3. The City of Novi shall be added as an additional insured. Certificates of Insurance evidencing such coverage shall be submitted to City of Novi, Purchasing Department, 45175 West Ten Mile Road, Novi, Michigan 48375-3024 prior to commencement of performance under this Contract and at least fifteen (15) days prior to the expiration dates of expiring policies.
4. The Contractor shall be responsible for payment of all deductibles contained in any insurance required hereunder.
5. If, during the term of this Contract, changed conditions or other pertinent factors should in the reasonable judgment of the City render inadequate insurance limits, the Contractor will furnish on demand such additional coverage as may reasonably be required under the circumstances. All such insurance shall be effected at the Contractor's expense, under valid and enforceable policies, issued by the insurers of recognized responsibility which are well-rated by national rating organizations and are acceptable to the City.
6. If any work is sublet in connection with this Contract, the Contractor shall require each subcontractor to effect and maintain at least the same types and limits of insurance as fixed for the Contractor.

7. The provisions requiring the Contractor to carry said insurance shall not be construed in any manner as waiving or restricting the liability of the Contractor under this contract.
8. The City has the authority to vary from the specified limits as deemed necessary.

ADDITIONAL REQUIREMENTS
Indemnity/Hold Harmless

1. The Contractor agrees to save harmless and defend the City against and from any or all liability, loss or damages (including without limitations, fees and expenses of attorneys, expert witnesses and other consultants) which the City may suffer as a result of claims, demands, costs, or judgments against it arising from, out of or in consequence of the performance of this Agreement, excepting only such liability, loss or damage as shall have been occasioned by the sole negligence of the City of Novi, its officers, agents or employees.
2. The Contractor agrees that it is its responsibility and not the responsibility of the City of safeguard the property and materials used in performing this Contract. Further the Contractor agrees to hold the City harmless for any loss of such property and materials used in pursuant to the Contractor's performance under this Contract.
3. The Contractor shall not discriminate against any employee, or applicant for employment because of race, color, sex, age, or handicap, religion, ancestry, marital status, national origin, place of birth, or sexual preference. The Contractor further covenants that it will comply with the Civil Rights Act of 1973, as amended; and the Michigan Civil Rights Act of 1976 (78. Stat. 252 and 1976 PA 453) and will require a similar covenant on the part of any consultant or subcontractor employed in the performance of this contract.

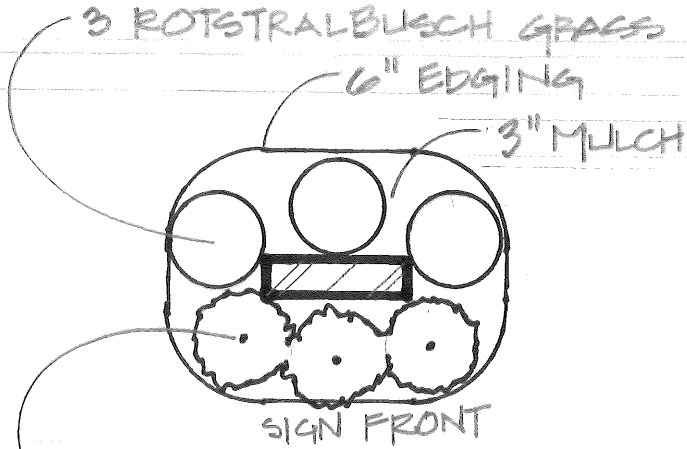

3 DRAGONS BLOOD SEDUM

WAYFARING SIGN

SINGLE SIDED (3)

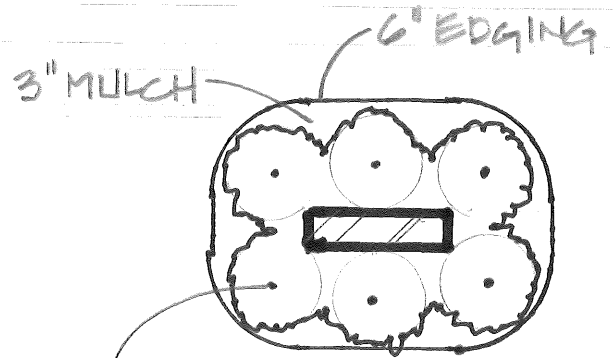

6 DRAGONS BLOOD SEDUM

WAYFARING SIGN

DOUBLE SIDED (3)

5 SKYROCKET JUNIPER

6" METAL EDGING
ALUMINUM PERMALOC
(OR APP. EQUAL)

4" HARDWOOD
MULCH

9 PLUMBAGO

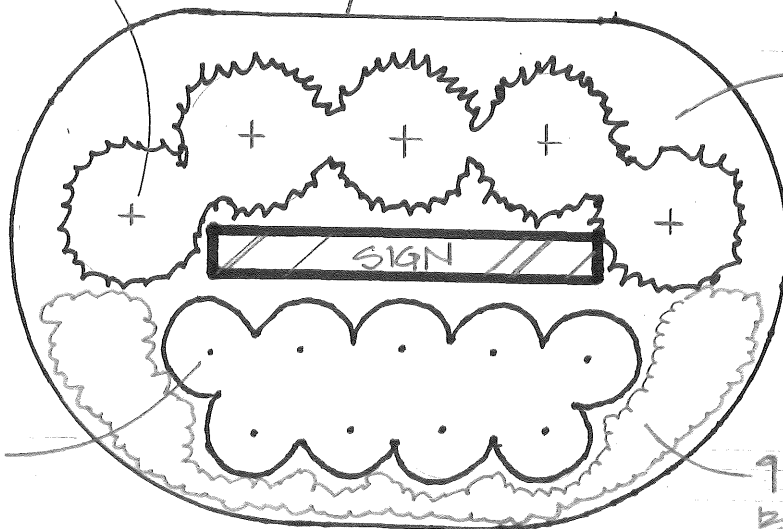

1 DRAGONS
BLOOD SEDUM

... WELCOME SIGN ...

1/4" = 1'

NOTE:

GUY DECIDUOUS TREES ABOVE 3" CAL.. STAKE DECIDUOUS TREES BELOW 3" CAL.

STAKE TREES AT FIRST BRANCH USING BELT-LIKE FABRIC STRAPS. ALLOW FOR SOME MINIMAL FLEXING OF THE TREE. REMOVE AFTER ONE YEAR.

2" X 2" HARDWOOD STAKES, MIN. 36" ABOVE GROUND FOR UPRIGHT, 18" IF ANGLED. DRIVE STAKES A MIN. 18" INTO UNDISTURBED GROUND OUTSIDE ROOTBALL. REMOVE AFTER ONE YEAR.

MULCH 4" DEPTH WITH SHREDDED HARDWOOD BARK. NATURAL IN COLOR. LEAVE 3" CIRCLE OF BARE SOIL AT BASE OF TREE TRUNK.

MOUND EARTH TO FORM SAUCER

REMOVE ALL NON-BIODEGRADABLE MATERIALS COMPLETELY FROM THE ROOTBALL. CUT DOWN WIRE BASKET AND FOLD DOWN BURLAP FROM TOP 1/2 OF THE ROOTBALL.

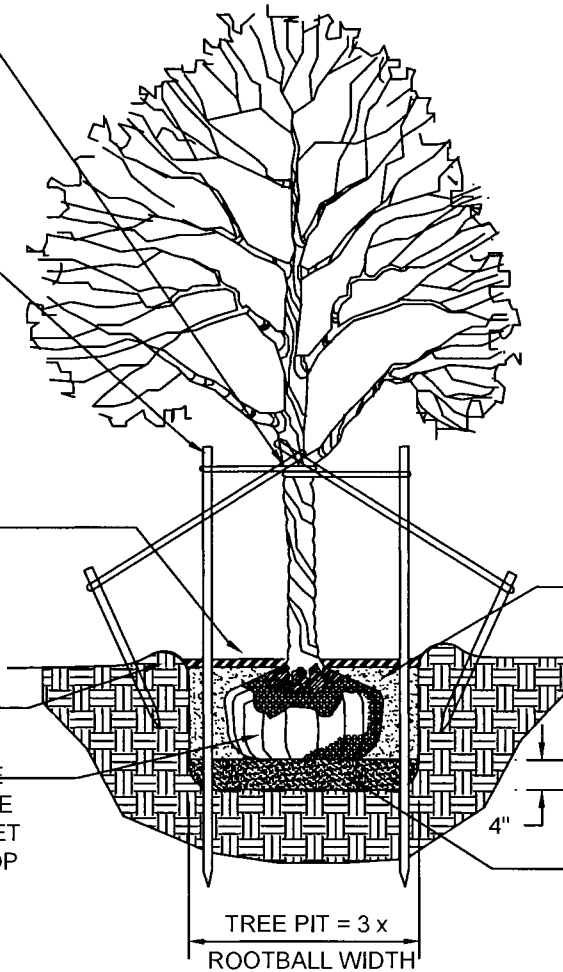

NOTE:

TREE SHALL BEAR SAME RELATION TO FINISH GRADE AS IT BORE ORIGINALLY OR SLIGHTLY HIGHER THAN FINISH GRADE UP TO 6" ABOVE GRADE, IF DIRECTED BY LANDSCAPE ARCHITECT FOR HEAVY CLAY SOIL AREAS.

DO NOT PRUNE TERMINAL LEADER. PRUNE ONLY DEAD OR BROKEN BRANCHES.

REMOVE ALL TAGS, STRING, PLASTICS AND OTHER MATERIALS THAT ARE UNSIGHTLY OR COULD CAUSE GIRDLING.

PLANTING MIXTURE: AMEND SOILS PER SITE CONDITIONS AND REQUIREMENTS OF THE PLANT MATERIAL.

SCARIFY SUBGRADE AND PLANTING PIT SIDES. RECOMPACT BASE OF TO 4" DEPTH.

DECIDUOUS TREE PLANTING DETAIL

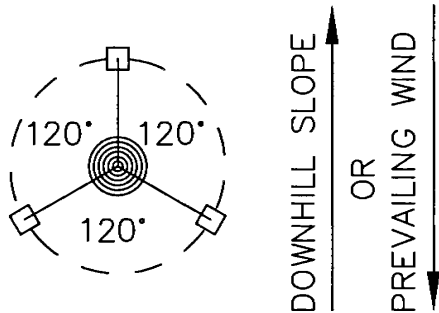

NOTE:

ORIENT STAKING/GUYING TO PREVAILING WINDS, EXCEPT ON SLOPES GREATER THAN 3:1 ORIENT TO SLOPE.

USE SAME STAKING/GUYING ORIENTATION FOR ALL PLANTS WITHIN EACH GROUPING OR AREA

STAKING/GUYING LOCATION

2"-3" WIDE BELT-LIKE FABRIC STRAPS.

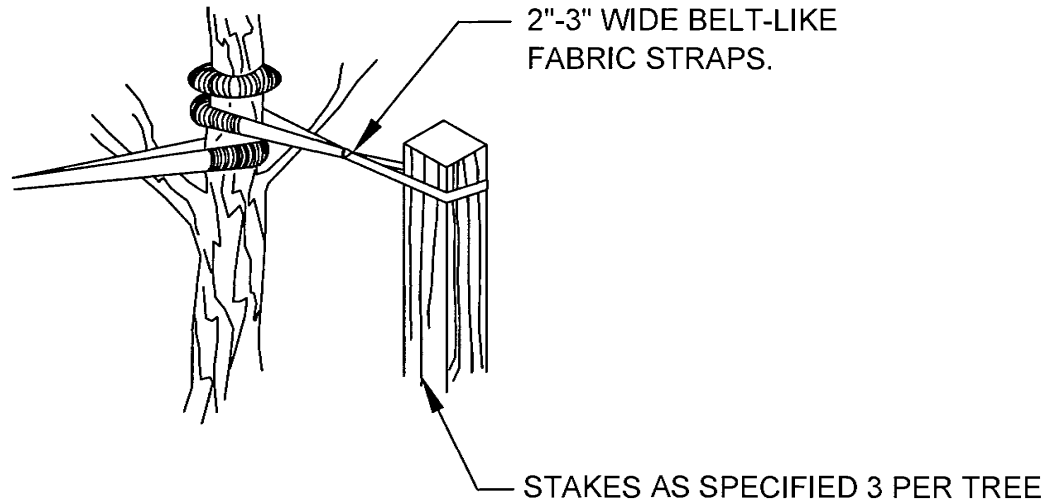
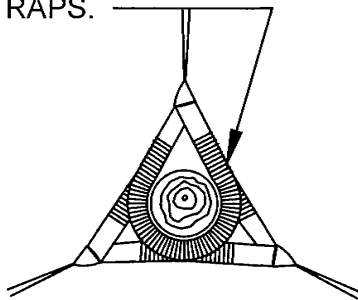

GUYING DETAIL

STAKING DETAIL

TREE STAKING DETAIL

Not to scale

NOTE:
GUY EVERGREEN TREES ABOVE 12'
HEIGHT. STAKE EVERGREEN TREE
BELOW 12' HEIGHT

STAKE TREES AT FIRST BRANCH
USING 2"-3" WIDE BELT-LIKE
FABRIC STRAPS. ALLOW FOR SOME
MINIMAL FLEXING OF THE TREE.
REMOVE AFTER ONE YEAR.

2" X 2" HARDWOOD STAKES, MIN.
36" ABOVE GROUND FOR UPRIGHT,
18" IF ANGLED. DRIVE STAKES A
MIN. 18" INTO UNDISTURBED
GROUND OUTSIDE ROOTBALL.
REMOVE AFTER ONE YEAR.

MULCH 4" DEPTH WITH SHREDDED
HARDWOOD BARK. NATURAL IN
COLOR. LEAVE 3" CIRCLE OF BARE
SOIL AT BASE OF TREE TRUNK.

MOUND EARTH TO FORM SAUCER

REMOVE ALL NON-BIODEGRADABLE
MATERIALS COMPLETELY FROM THE
ROOTBALL. CUT DOWN WIRE BASKET
AND FOLD DOWN BURLAP FROM TOP
1/2 OF THE ROOTBALL.

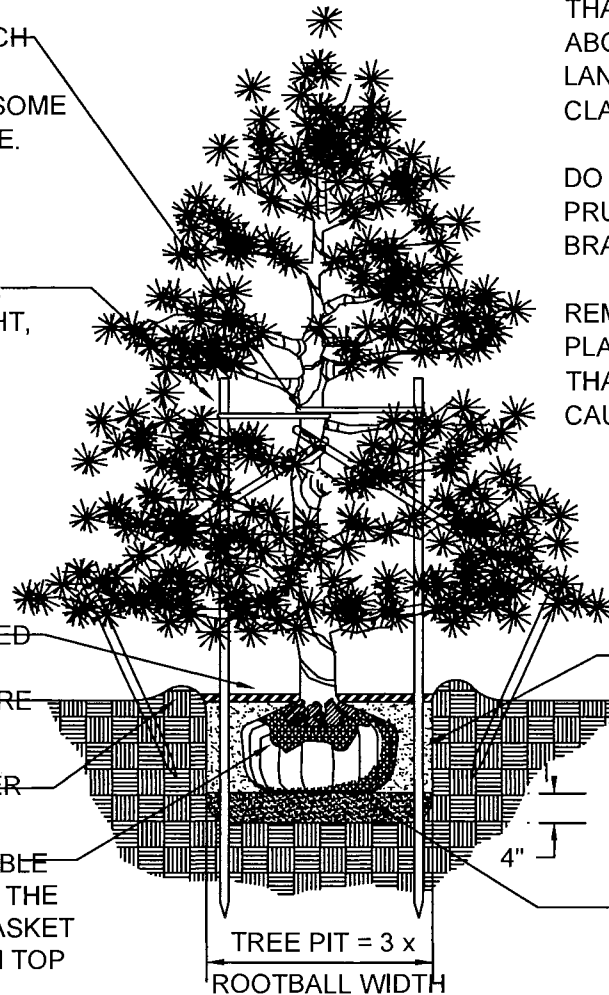

NOTE:
TREE SHALL BEAR SAME RELATION
TO FINISH GRADE AS IT BORE
ORIGINALLY OR SLIGHTLY HIGHER
THAN FINISH GRADE UP TO 6"
ABOVE GRADE, IF DIRECTED BY
LANDSCAPE ARCHITECT FOR HEAVY
CLAY SOIL AREAS.

DO NOT PRUNE TERMINAL LEADER.
PRUNE ONLY DEAD OR BROKEN
BRANCHES.

REMOVE ALL TAGS, STRING,
PLASTICS AND OTHER MATERIALS
THAT ARE UNSIGHTLY OR COULD
CAUSE GIRDLING.

PLANTING MIXTURE:
AMEND SOILS PER SITE
CONDITIONS AND
REQUIREMENTS OF THE
PLANT MATERIAL.

SCARIFY SUBGRADE
AND PLANTING PIT
SIDES. RECOMPACT
BASE OF TO 4" DEPTH.

NOTES:

PRUNE AS SPECIFIED
STAKE 3 LARGEST STEMS, IF TREE
HAS MORE THAN 3 LEADERS
SET TREE STAKES VERTICAL AND
AT SAME HEIGHT.

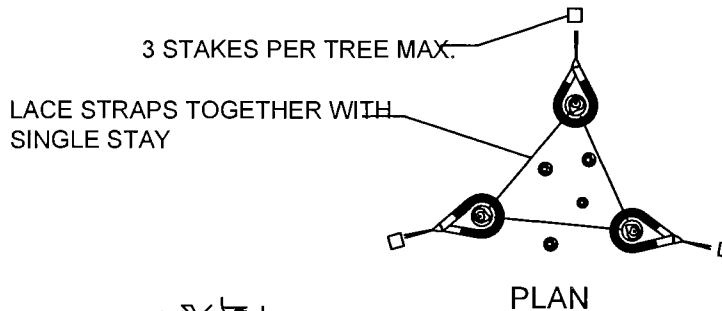

MOUND TO FORM SAUCER

4" OF MULCH

REMOVE ALL NON-BIODEGRADABLE
MATERIALS COMPLETELY FROM THE
ROOTBALL. CUT DOWN WIRE BASKET
AND FOLD DOWN BURLAP FROM TOP
 $\frac{1}{3}$ OF THE ROOTBALL.

PLANT MIXTURE AS SPECIFIED

SCARIFY TO 4" DEPTH AND
RECOMPACT

STAKES TO EXTEND 12" BELOW
TREE PIT IN UNDISTURBED
GROUND

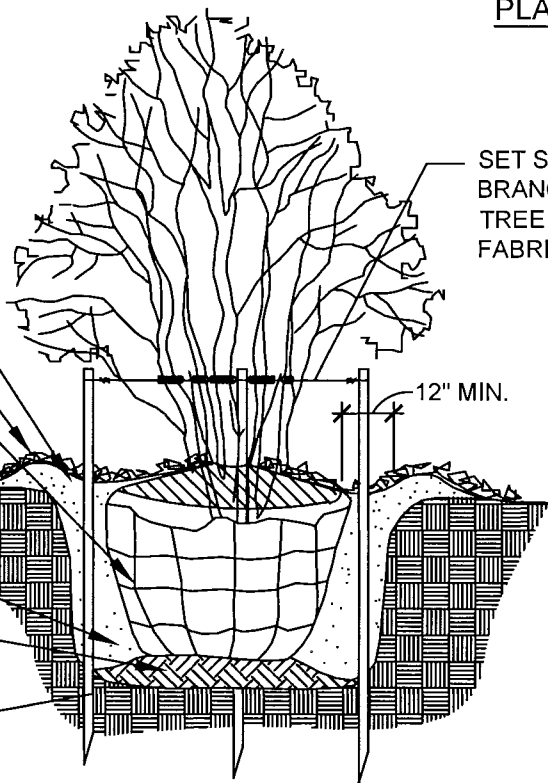

SET STAYS ABOVE FIRST
BRANCHES, APPROX. HALFWAY UP
TREE (SEE DETAIL).
FABRIC STRAPS ONLY.

MULTI-STEM TREE PLANTING DETAIL

Not to scale

ROOTWELL™ INSTALLATION GUIDE FOR NEWLY PLANTED TREES

(For All Tree Species)

Place four Rootwell Pro-318 units evenly around the root ball near the outside edge of the planting pit. See location tip.

Place Rootwell in the ground so the top is 1" above the ground surface or level with mulch layer within the pit area. It is important the top area is kept open to the air. Do not cover.

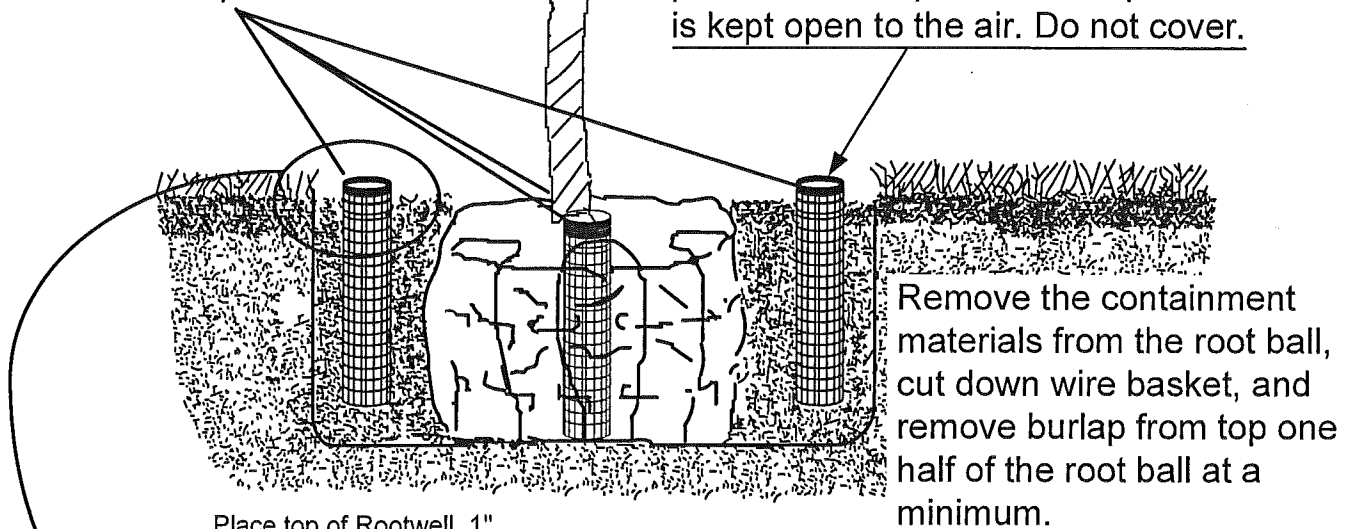

Place top of Rootwell 1" above soil or mulch level

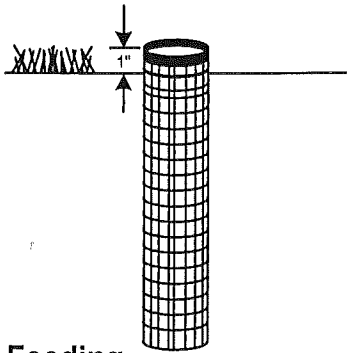

Remove the containment materials from the root ball, cut down wire basket, and remove burlap from top one half of the root ball at a minimum.

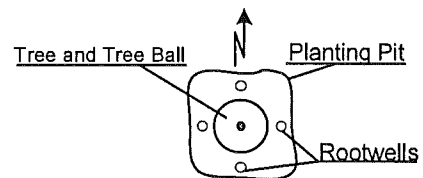

Tips

- 1) Place Rootwells around the tree in a compass coordinate; North, East, West, South for ease of finding in the future.
- 2) The purpose of placing the Rootwell 1" above the ground or mulch is to avoid debris from covering the top area. And allow ease of watering and feeding.

Watering & Feeding

1. Water 2-3 times weekly. Soil must be allowed to dry out between watering. If soil is holding water, reduce watering times.
2. Fill Rootwell Pro-318 with water via the center hole on the top. Fill until the water overflows, or the earth in the pit is moist.
3. Do not cover the tops of the Rootwells with any materials, soil, or mulch. It must remain exposed for air convection to occur.
4. Tree species specific fertilizer may be poured into the Rootwells through the same opening. Pre-mixed water soluble is preferred.
5. It is always recommended to consult your local tree and shrub nursery for proper fertilizers, feeding and watering instructions, for optimal growth for the type of soil and the climate where the tree is planted.

Pro Arbor contact information placed here.

Please define

City Entryway Signage Placement

Remaining 2009-10 Novi Sign Package Locations

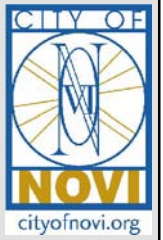

Entrance Signs

- E FY 09-10 Entryway Sign Paid by Developer (1 - Alternate 1)
- E FY 09-10 Proposed Entryway (5 - Building and Grounds)
- W FY 09-10 Proposed Wayfinding (6 - Building and Grounds)
- W FY 09-10 Proposed Wayfinding (3 - Alternates 3, 4, & 5)
- P FY 09-10 Proposed Park (6 - Parks - Alternate 2)

LEGEND

- Lakes
- Civic Center
- DPW
- Police Station
- Fire Station
- 52-1 District Court
- Hospital
- Library
- Ice Arena
- School
- Senior Center
- Post Office
- Recycling

- Freeways
- Major Public Streets
- Minor Public Streets
- Privately Maintained Streets

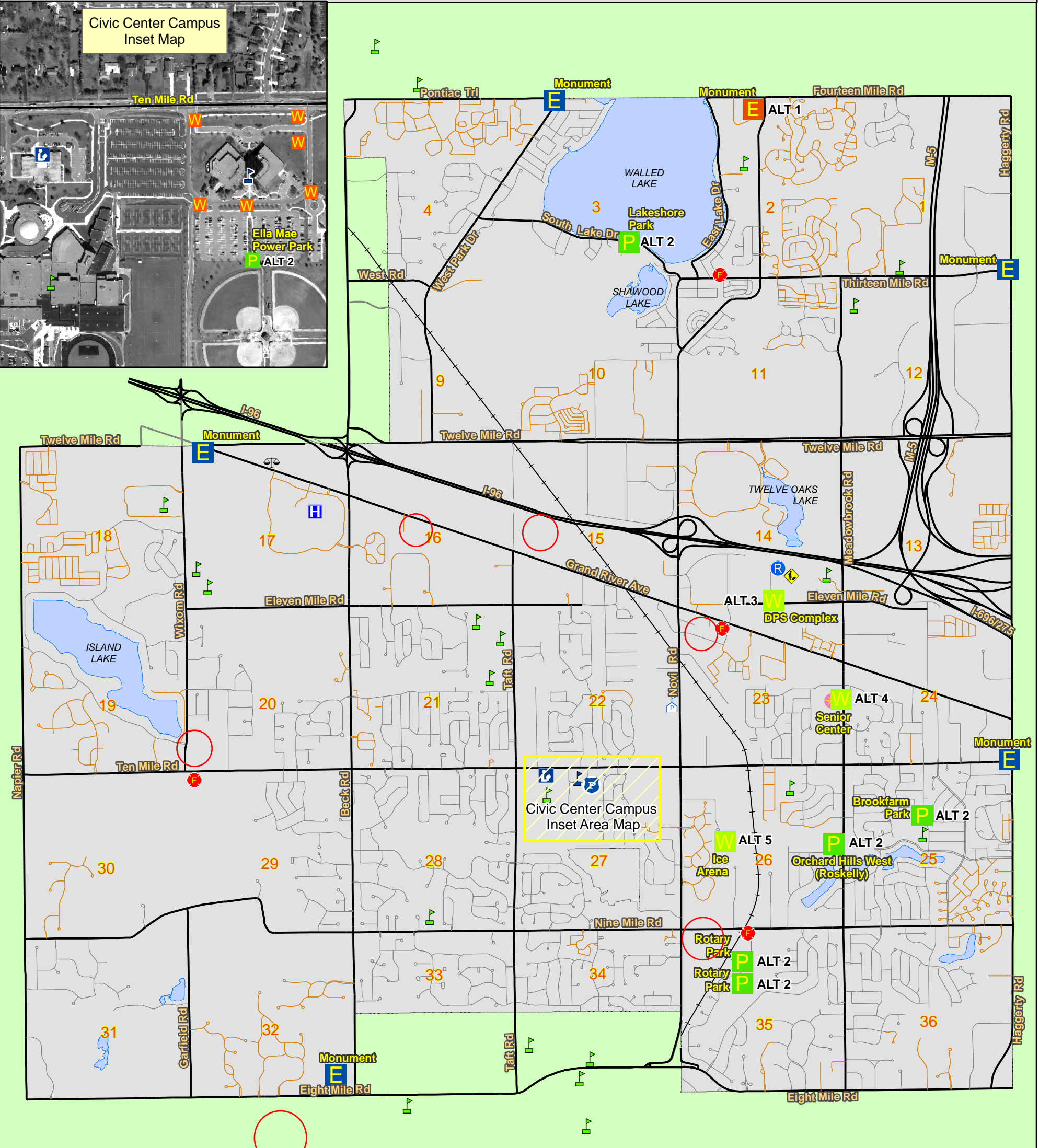
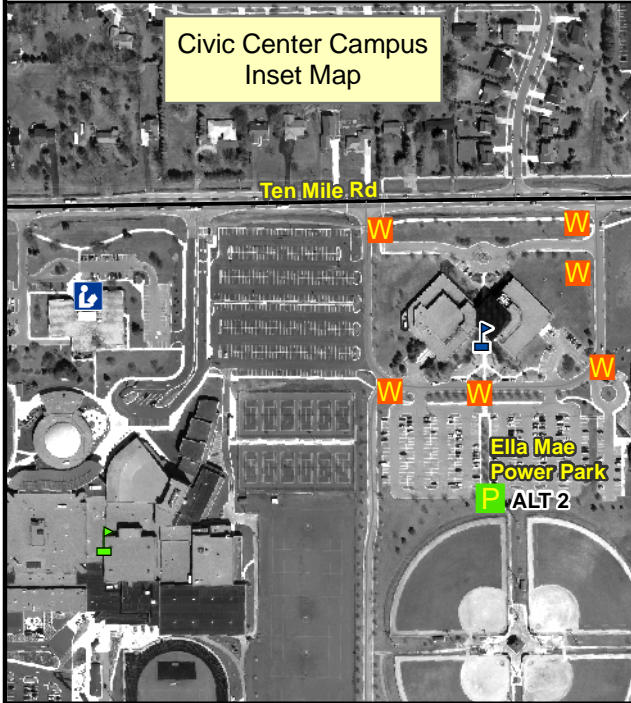

CITY OF NOVI

GEOGRAPHIC INFORMATION SERVICES
INFORMATION TECHNOLOGY DEPARTMENT

45175 W. TEN MILE ROAD
NOVI, MI 48375-3024
(248) 347-3279

MAP AUTHOR: CHRIS BLOUGH,
CITY GIS MANAGER



0 1,950 3,900 7,800

FEET

1 INCH = 3,250 FEET

MAP PRINT DATE: 2/23/2010

SOURCES OF INFORMATION

City Street Centerline - City GIS Manager
Sign Locations - City Community Relations/
Manager's Office

MAP INTERPRETATION NOTICE

Map information depicted is not intended to replace or substitute for any official or primary source. This map was intended to meet National Map Accuracy Standards and use the most recent, accurate sources available to the people of the City of Novi. Boundary measurements and area calculations are approximate and should not be construed as survey measurements performed by a licensed Michigan Surveyor as defined in Michigan Public Act 132 of 1970 as amended. Please contact the City GIS Manager to confirm source and accuracy information related to this map.

Civic Center Entryway Signage Placement

Remaining 2009-10 Novi Sign Package Locations

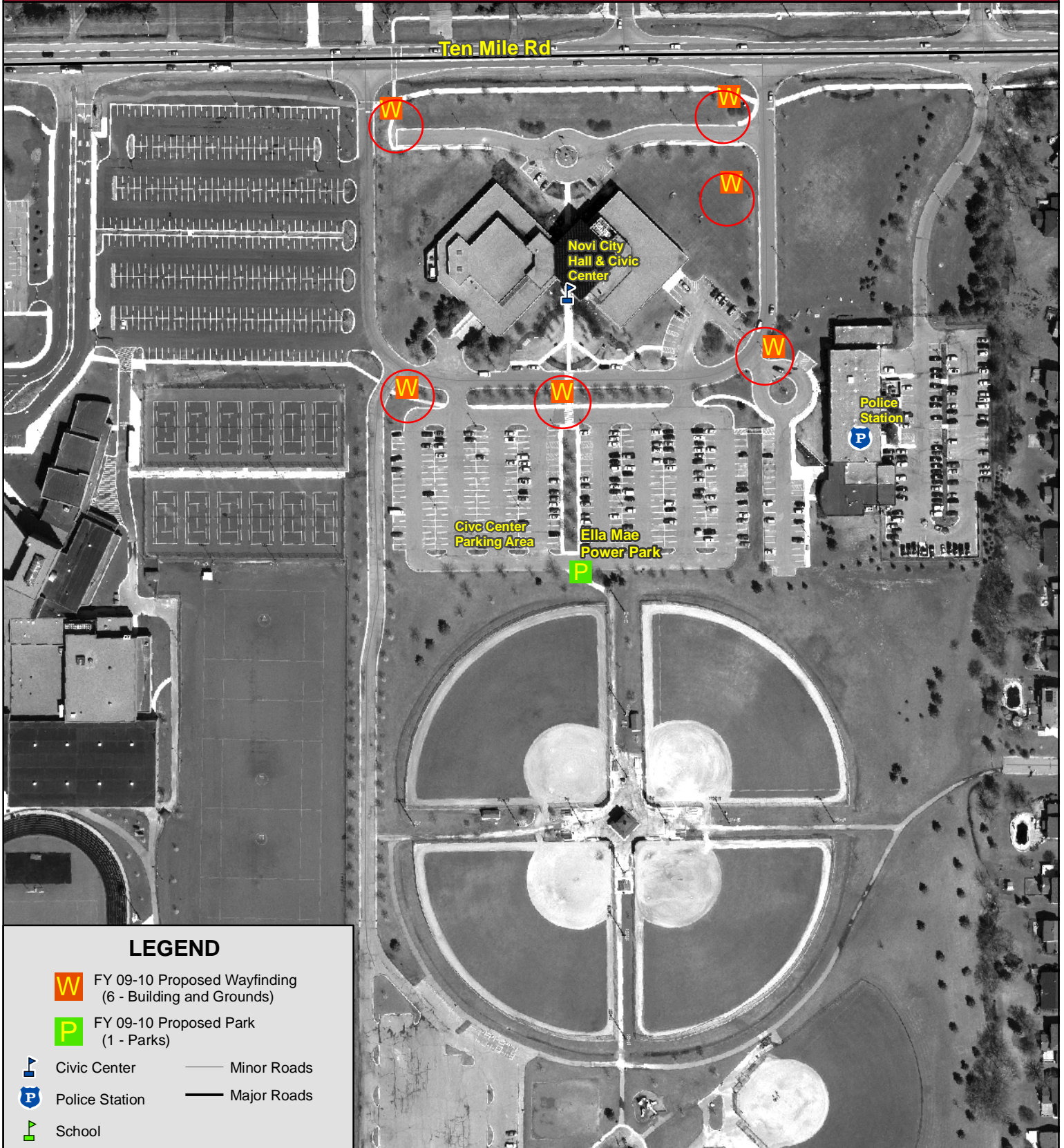

LEGEND

- FY 09-10 Proposed Wayfinding (6 - Building and Grounds)
- FY 09-10 Proposed Park (1 - Parks)
- Civic Center
- Police Station
- School
- Minor Roads
- Major Roads

CITY OF NOVI

GEOGRAPHIC INFORMATION SERVICES
 INFORMATION TECHNOLOGY DEPARTMENT
 45175 W. TEN MILE ROAD
 NOVI, MI 48375-3024
 (248) 347-0415
 MAP AUTHOR: CHRIS BLOUGH, GIS MANAGER



1 INCH = 200 FEET

MAP PRINT DATE: 2/03/2010

MAP INTERPRETATION NOTICE

Map information depicted is not intended to replace or substitute for any official or primary source. This map was intended to meet National Map Accuracy Standards and use the most recent, accurate sources available to the people of the City of Novi. Boundary measurements and area calculations are approximate and should not be construed as survey measurements performed by a licensed Michigan Surveyor as defined in Michigan Public Act 132 of 1970 as amended. Please contact the City GIS Manager to confirm source and accuracy information related to this map.

West Park Drive & Pontiac Trail



Proposed Entryway Sign Location

Pontiac Tr & West Rd



Map Legend



| Legend | |
|--------|----------|
| | 1.5" FM |
| | 2.0" FM |
| | 3.0" FM |
| | 4.0" FM |
| | 6.0" |
| | 6.0" FM |
| | 8.0" |
| | 8.0" FM |
| | 10.0" |
| | 10.0" FM |
| | 12.0" |
| | 12.0" FM |
| | 15.0" |
| | 18.0" |
| | 18.0" FM |
| | 21.0" |
| | 27.0" |
| | 30.0" |
| | 36.0" |
| | 42.0" |
| | ABND |

| Legend | |
|--------|--------|
| | 2 |
| | 4 |
| | 6 |
| | 8 |
| | 10 |
| | 12 |
| | 16 |
| | 20 |
| | 24 |
| | 24 DMS |
| | 30 |
| | 30 DMS |
| | 36 |
| | 42 DMS |

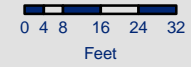

1 inch = 40 feet



City of Novi
 45175 W Ten Mile Rd
 Novi, MI 48375
 cityofnovi.org

Map Author: Lindon Ivezaj
 Date: 2-16-10
 Project: Entryway signs (all signs must remain 10-feet from public utilities and a minimum of 3-feet from sidewalks/pathways)
 Version #: 1.0

MAP INTERPRETATION NOTICE

Map information depicted is not intended to replace or substitute for any official or primary source. This map was intended to meet National Map Accuracy Standards and use the most recent, accurate sources available to the people of the City of Novi. Boundary measurements and area calculations are approximate and should not be construed as survey measurements performed by a licensed Michigan Surveyor as defined in Michigan Public Act 132 of 1970 as amended. Please contact the City GIS Manager to confirm source and accuracy information related to this map.

Novi Road & Fourteen Mile Road



Proposed Entryway Sign Location

Fourteen Mile & Novi Rd
(To be installed by Maple Manor)

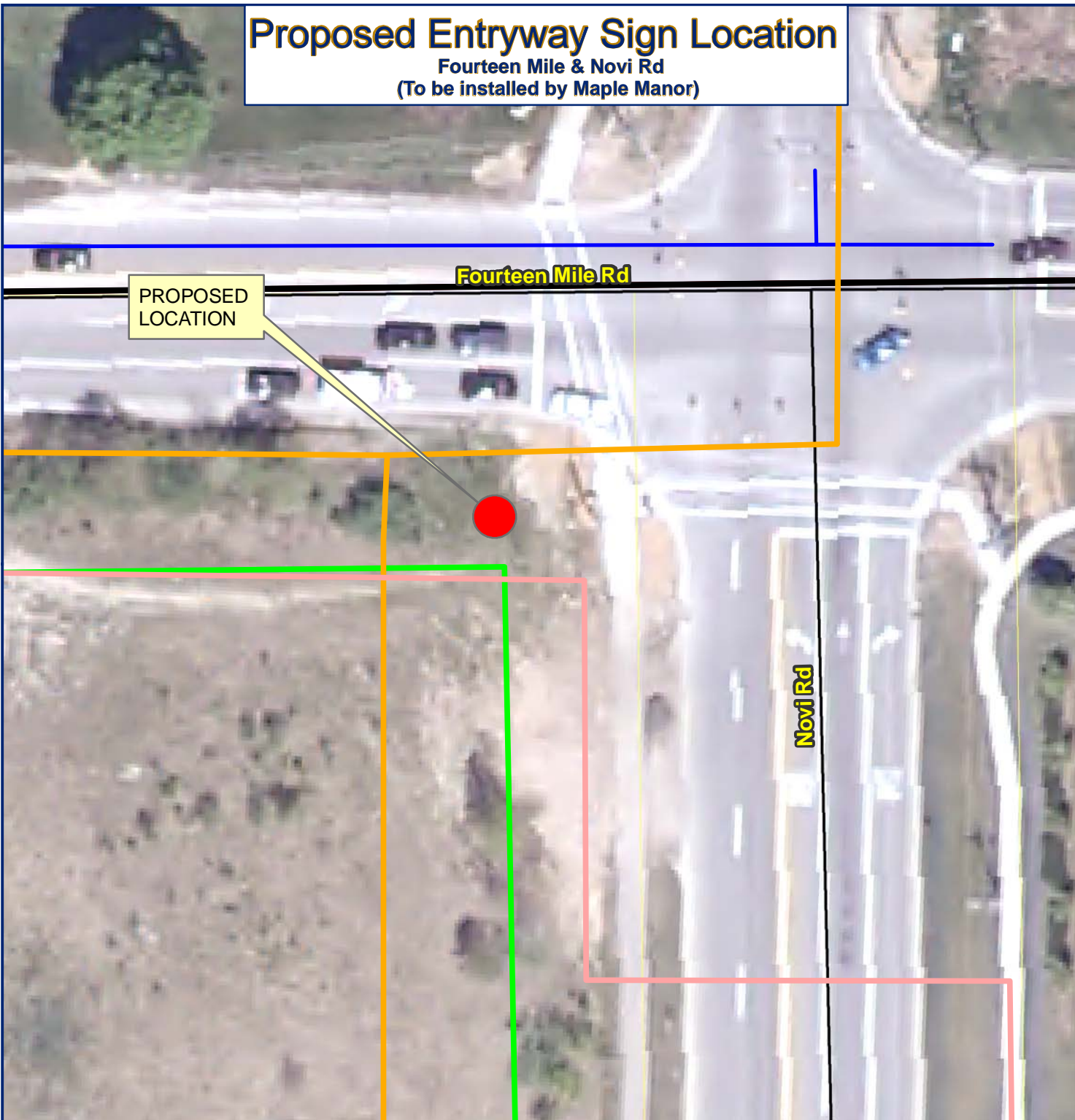

Map Legend



Legend

- 1.5" FM
- 2.0" FM
- 3.0" FM
- 4.0" FM
- 6.0"
- 6.0" FM
- 8.0"
- 8.0" FM
- 10.0"
- 10.0" FM
- 12.0"
- 12.0" FM
- 15.0"
- 18.0"
- 18.0" FM
- 21.0"
- 27.0"
- 30.0"
- 36.0"
- 42.0"
- ABND

Legend

- 2
- 4
- 6
- 8
- 10
- 12
- 16
- 20
- 24
- 24 DMS
- 30
- 30 DMS
- 36
- 42 DMS



1 inch = 38 feet



City of Novi
45175 W Ten Mile Rd
Novi, MI 48375
cityofnovi.org

Map Author: Lindon Ivezaj
Date: 2-16-10
Project: Entryway signs (all signs must remain 10-feet from public utilities and a minimum of 3-feet from sidewalks/pathways)
Version #: 1.0

MAP INTERPRETATION NOTICE

Map information depicted is not intended to replace or substitute for any official or primary source. This map was intended to meet National Map Accuracy Standards and use the most recent, accurate sources available to the people of the City of Novi. Boundary measurements and area calculations are approximate and should not be construed as survey measurements performed by a licensed Michigan Surveyor as defined in Michigan Public Act 132 of 1970 as amended. Please contact the City GIS Manager to confirm source and accuracy information related to this map.

Beck Road & Stratford Lane



Thirteen Mile Road & Haggerty Road



Proposed Entryway Sign Location

Thirteen Mile & Haggerty

PROPOSED LOCATION



Thirteen Mile Rd

Haggerty Rd

Map Legend



Legend

- 1.5" FM
- 2.0" FM
- 3.0" FM
- 4.0" FM
- 6.0"
- 6.0" FM
- 8.0"
- 8.0" FM
- 10.0"
- 10.0" FM
- 12.0"
- 12.0" FM
- 15.0"
- 18.0"
- 18.0" FM
- 21.0"
- 27.0"
- 30.0"
- 36.0"
- 42.0"
- ABND

Legend

- 2
- 4
- 6
- 8
- 10
- 12
- 16
- 20
- 24
- 24 DMS
- 30
- 30 DMS
- 36
- 42 DMS

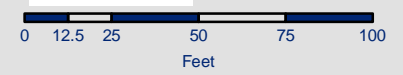

1 inch = 55 feet



City of Novi
 45175 W Ten Mile Rd
 Novi, MI 48375
 cityofnovi.org

Map Author: Lindon Ivezaj
 Date: 2-16-10
 Project: Entryway signs (all signs must remain 10-feet from public utilities and a minimum of 3-feet from sidewalks/pathways)
 Version #: 1.0

MAP INTERPRETATION NOTICE

Map information depicted is not intended to replace or substitute for any official or primary source. This map was intended to meet National Map Accuracy Standards and use the most recent, accurate sources available to the people of the City of Novi. Boundary measurements and area calculations are approximate and should not be construed as survey measurements performed by a licensed Michigan Surveyor as defined in Michigan Public Act 132 of 1970 as amended. Please contact the City GIS Manager to confirm source and accuracy information related to this map.

Ten Mile Road & Haggerty Road



Proposed Entryway Sign Location

Ten Mile & Haggerty

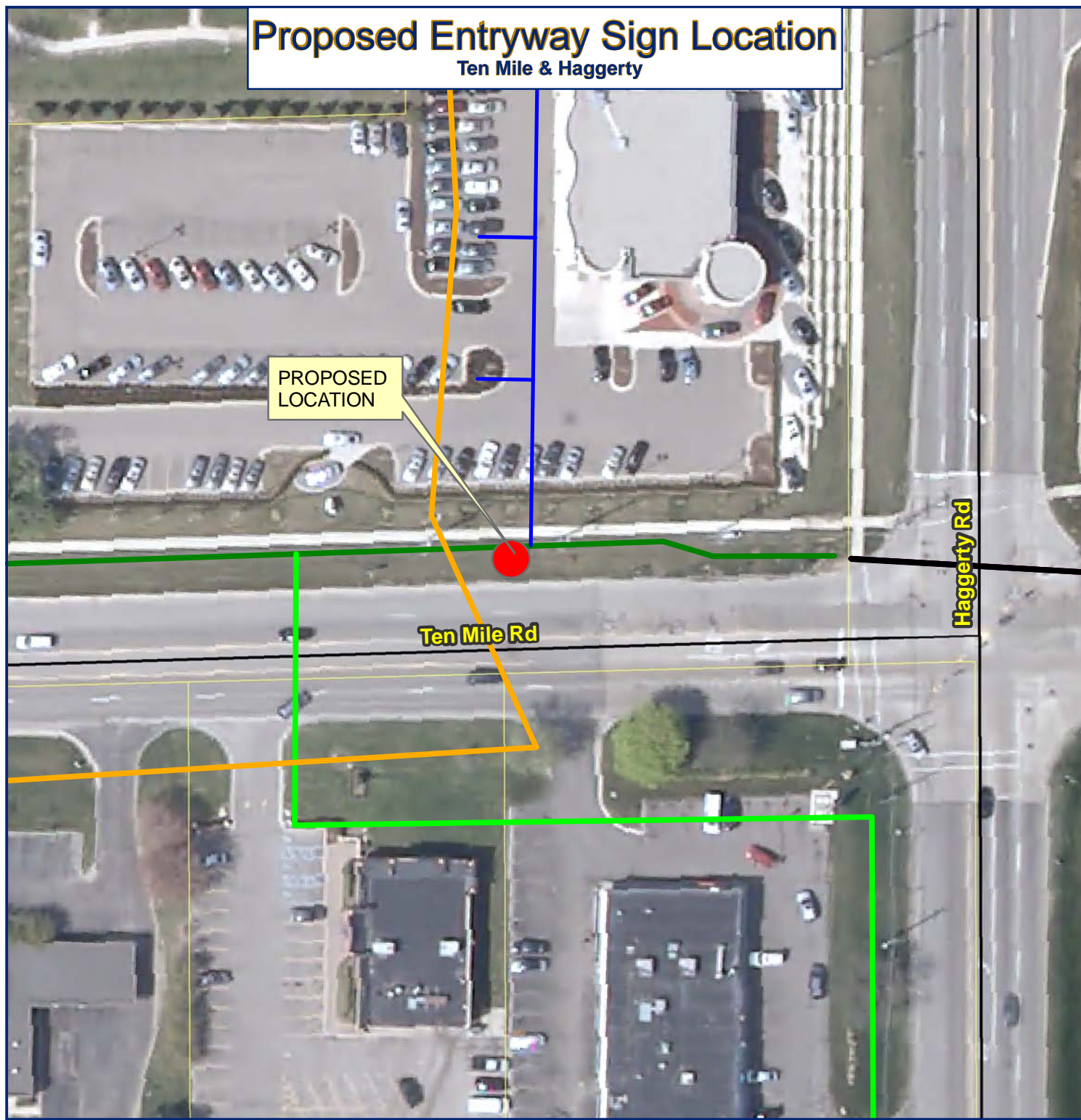

Map Legend

Legend

- 1.5" FM
- 2.0" FM
- 3.0" FM
- 4.0" FM
- 6.0"
- 6.0" FM
- 8.0"
- 8.0" FM
- 10.0"
- 10.0" FM
- 12.0"
- 12.0" FM
- 15.0"
- 18.0"
- 18.0" FM
- 21.0"
- 27.0"
- 30.0"
- 36.0"
- 42.0"
- ABND

Legend

- 2
- 4
- 6
- 8
- 10
- 12
- 16
- 20
- 24
- 24 DMS
- 30
- 30 DMS
- 36
- 42 DMS

1 inch = 66 feet

City of Novi

45175 W Ten Mile Rd
Novi, MI 48375
cityofnovi.org

Map Author: Lindon Ivezaj
Date: 2-16-10
Project: Entryway signs (all signs must remain 10-feet from public utilities and a minimum of 3-feet from sidewalks/pathways)
Version #: 1.0

MAP INTERPRETATION NOTICE

Map information depicted is not intended to replace or substitute for any official or primary source. This map was intended to meet National Map Accuracy Standards and use the most recent, accurate sources available to the people of the City of Novi. Boundary measurements and area calculations are approximate and should not be construed as survey measurements performed by a licensed Michigan Surveyor as defined in Michigan Public Act 132 of 1970 as amended. Please contact the City GIS Manager to confirm source and accuracy information related to this map.

Grand River Avenue & Wixom Road



Proposed Entryway Sign Location

Twelve Mile & Grand River

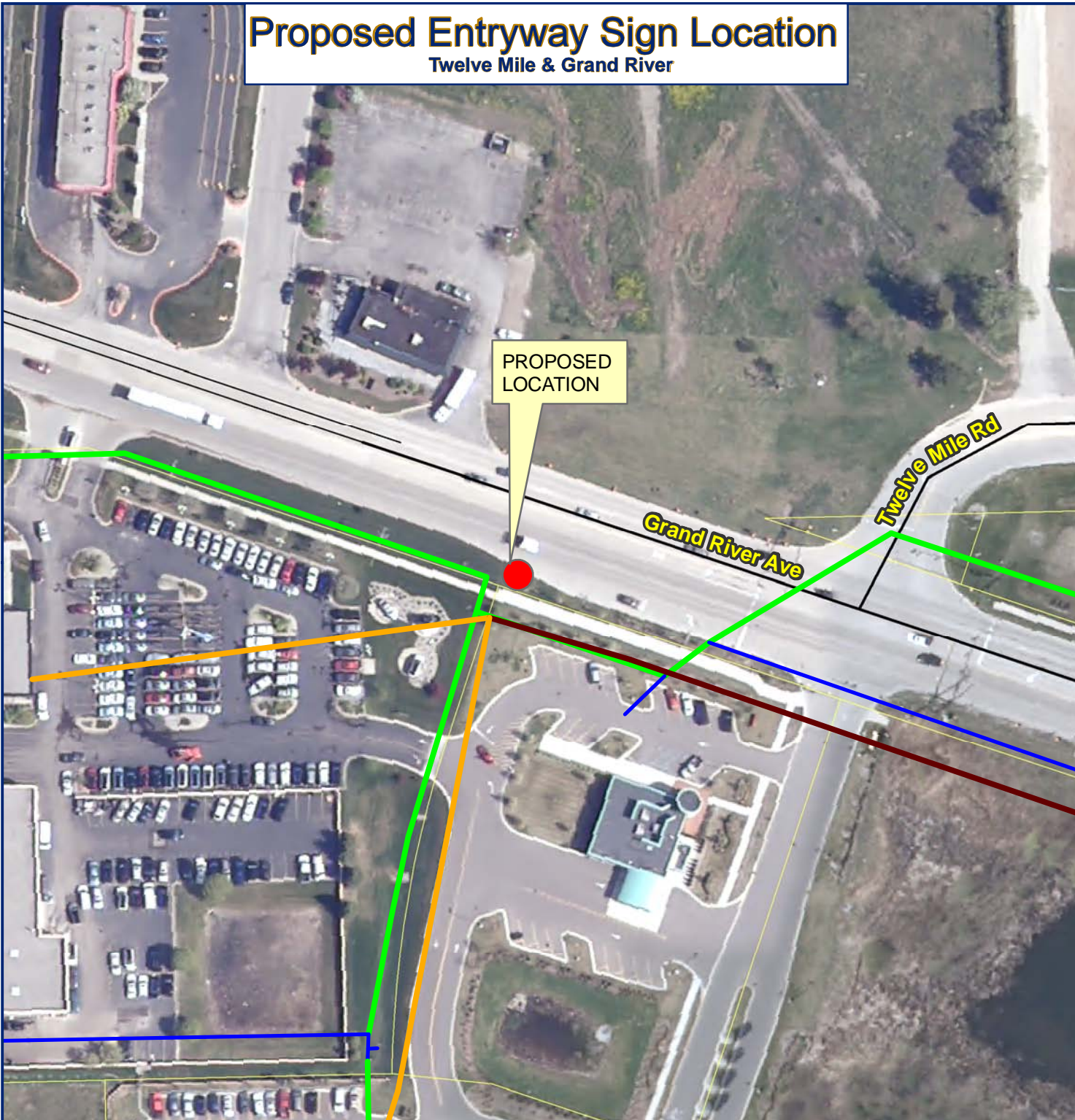

Map Legend



Legend

- 1.5" FM
- 2.0" FM
- 3.0" FM
- 4.0" FM
- 6.0"
- 6.0" FM
- 8.0"
- 8.0" FM
- 10.0"
- 10.0" FM
- 12.0"
- 12.0" FM
- 15.0"
- 18.0"
- 18.0" FM
- 21.0"
- 27.0"
- 30.0"
- 36.0"
- 42.0"
- ABND

Legend

- 2
- 4
- 6
- 8
- 10
- 12
- 16
- 20
- 24
- 24 DMS
- 30
- 30 DMS
- 36
- 42 DMS

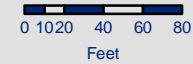

1 inch = 97 feet



City of Novi
 45175 W Ten Mile Rd
 Novi, MI 48375
 cityofnovi.org

Map Author: Lindon Ivezaj
 Date: 2-16-10
 Project: Entryway signs (all signs must remain 10-feet from public utilities and a minimum of 3-feet from sidewalks/pathways)
 Version #: 1.0

MAP INTERPRETATION NOTICE

Map information depicted is not intended to replace or substitute for any official or primary source. This map was intended to meet National Map Accuracy Standards and use the most recent, accurate sources available to the people of the City of Novi. Boundary measurements and area calculations are approximate and should not be construed as survey measurements performed by a licensed Michigan Surveyor as defined in Michigan Public Act 132 of 1970 as amended. Please contact the City GIS Manager to confirm source and accuracy information related to this map.



CITY OF NOVI
2011 SPRING LANDSCAPE PLANTING
ADDENDUM #1

INTENT: This addendum has been issued to modify and/or interpret the original specifications for the bid/RFP named above. Unless otherwise instructed, the information contained within this Addendum shall take precedence over anything contrary in the original specifications, and shall hereinafter be considered as part of the package.

RESPONSE: The Contractor shall verify receipt of this Addendum in the Bid Proposal Form.

CONTENTS: Included in this Addendum are ten (10) pages of written addenda description including the pre-bid meeting sign-in sheets.

CLARIFICATIONS/CORRECTIONS:

1. Page 8, Sect. 4. B. should read: Planting shall commence no later than twenty **(20)** days after the contract has been awarded.
2. The size of trees required for Bid #4: Brookfarm Park Tree Planting is **2-1/2" caliper**.
3. **We do not require a warranty on the trees in Bid #4. Please use the revised bid form included in this addendum.**
4. **PERFORMANCE BOND** - The successful bidder will be required to enter into a contract with the City of Novi. A performance bond equal to one hundred percent (100%) of the contract sum shall be required. The bond must be provided to the City within 15 days of the award. **Sample of bond with required language is attached. Contractor must include a letter from their bonding company with their bid that indicates that they are able to obtain a performance bond with the City's required language.**
5. Water will be provided at no charge to the contractor for watering the trees planted in this bid. Water will be available at the DPS facility at 26300 Delwal Dr. Novi, MI 48375.
6. The City will obtain the MDOT permit at the City's expense and the City will submit the required drawings.

QUESTIONS:

1. I see that you specify a retainage. Can you tell me what kind of interest bearing account our money is put into?
Answer: The City is not required to pay interest on the retainage since it is not a construction project. Contractor should take this into consideration when bidding.

2. For the boulders needed for the Pontiac Trail/West Park Drive welcome sign, can we get a length or face feet?
Answer: Contractor is responsible for determining quantity needed to provide a level planting area.
3. Is the project on M-5 to be paid at MDOT scale?
Answer: No.
4. Who is responsible for watering?
Answer: The contractor is responsible for watering.
5. Are the sites irrigated?
Answer: No.
6. On page 14, (Section 15 E.), it says the contractor "shall... furnish any additional material, equipment, or water to ensure adequate irrigation". Are we being asked to install irrigation?
Answer: No. You will need to water in the trees when planted and then maintain them. See clarification about availability of water in the section above.
7. Are we going to provide traffic control signage or will the City provide it?
Answer: The Contractor will provide any necessary traffic control signage.

Sue Morianti
Purchasing Manager

Notice dated: March 21, 2011



CITY OF NOVI
2011 SPRING LANDSCAPE PLANTING

OFFICIAL BID FORM **(REVISED)**

BID #4: Brookfarm Park Tree Planting

All trees 2.5 inch caliper unless specified otherwise.

All work will take place on the Brookfarm Park grounds. All trees will be part of a City Arbor Day function. All tree pits will be dug on Friday, May 6, 2011. Trees shall be placed in the plant pits. Final planting operations will be completed by City residents under the supervision of City Staff. City staff will stake all plant installation locations.

| Acceptable species of Plant Material | # of Trees | Source /Phone # | Unit Price (no warranty) | TOTAL |
|--|------------|-----------------|--------------------------|-------|
| Acer rubrum (Red Maple) | 5 | | | |
| Platanus x acerifolia (London Plane Tree) | 5 | | | |
| Tsuga canadensis (Hemlock) | 5 | | | |
| TOTAL | 15 | | | |

| Alternate B | Qty. | Source /Phone # | Unit Price | TOTAL |
|---|------|-----------------|------------|-------|
| 15" Standard Rootwell Pro 318D aeration sleeve (4 per tree) | 60 | | | |

PERFORMANCE BOND

KNOW ALL MEN BY THESE PRESENTS THAT _____
as Principal, hereinafter called the CONTRACTOR, and _____

as Surety, hereinafter called Surety, and held and firmly bound unto

CITY OF NOVI, MICHIGAN

as Obligee, hereinafter called the OWNER, in the amount of _____
_____ Dollars (\$ _____)

for the payment of which the CONTRACTOR and SURETY bind themselves, their heirs, executors, administrators, successors and assigns, jointly and severally, firmly by these presents.

WHEREAS, the CONTRACTOR has been awarded a Contract by the OWNER for the construction of

2011 Spring Landscape Planting

in accordance with Plans and Specifications prepared by *the City of Novi*, which award was conditioned on the CONTRACTOR providing this Performance Bond and which Contract upon being fully executed by the OWNER and the CONTRACTOR shall by reference automatically be made a part hereof, and is hereinafter referred to as "the Contract."

NOW, THEREFORE, THE CONDITION OF THIS OBLIGATION is such that, if the CONTRACTOR shall promptly and faithfully perform said Contract, in accordance with the terms and conditions of the Contract, then the CONTRACTOR and SURETY shall have no further obligation under this bond; otherwise it shall remain in full force and effect, subject, however, to the following conditions.

1. The SURETY hereby waives notice of any alteration or extension of time under the Contract made by the OWNER.

2. SURETY'S obligation under this Performance Bond shall arise after the OWNER has declared a Contractor Default as defined below, formally terminated the Contract or the CONTRACTOR'S right to complete the Contract, and notified the SURETY of the OWNER'S claim under this Performance Bond.

3. When the OWNER has satisfied the conditions of Paragraph 2 above, the SURETY shall, at the SURETY'S sole cost and expense, undertake one or more of the following actions:

a. Arrange for the CONTRACTOR to perform and complete the Contract; provided, however, that the SURETY may not proceed with this option, except upon the express written consent of the OWNER, which consent may be withheld by the OWNER for any reason; or

b. Perform and complete the Contract itself, through qualified contractors who are acceptable to the OWNER, through a contract between the SURETY and qualified contractors, performance and completion of which shall be undertaken in strict accordance with the terms and conditions of the Contract, including (but not limited to) time for completion; or

c. Tender payment to the OWNER in the amount of all losses incurred by the

OWNER as a result of the Contractor Default, as determined by the OWNER, for which the SURETY is liable to the OWNER, including all costs of completion of the Contract and all consequential losses, costs, and expenses incurred by the OWNER as a result of the Contractor Default, and including all unpaid fees or payments owed to the OWNER by the CONTRACTOR under the Contract, except that SURETY'S payment under this option shall in no event exceed the limit of the Bond Amount. The SURETY may not proceed with this option, in lieu of the options set forth in paragraphs (a) or (b) above, except upon the express written consent of the OWNER, which consent may be withheld by the OWNER for any reason.

4. The SURETY shall proceed under Paragraph 3, above, within fourteen (14) business days after notice from the OWNER to the SURETY of the Contractor Default, of the formal termination of the Contract or the CONTRACTOR'S right to complete the Contract, and of the OWNER'S intention to have SURETY complete the Contract, except that SURETY shall proceed within twenty-four (24) hours after notice where the notice states that immediate action by SURETY is necessary to safeguard life or property.

5. If SURETY fails to proceed in accordance with Paragraphs 3 and 4, above, then SURETY shall be deemed to be in default on this Performance Bond three (3) business days after receipt of written notice from OWNER to SURETY demanding that SURETY perform its obligations under this Performance Bond. Thereafter, if notice to SURETY is without effect, OWNER shall be entitled to enforce any legal or equitable remedies available to OWNER, including completion of the Contract by contractors of its own choosing or OWNER'S employees or agents, and CONTRACTOR and SURETY shall, jointly and severally, be liable for all costs of such completion and all consequential losses, costs, and expenses so incurred (including all unpaid fees and expenses owed to the OWNER by the CONTRACTOR as a result of the CONTRACTOR'S default).

6. After OWNER has terminated the Contract or the CONTRACTOR'S right to complete the Contract, and if SURETY is proceeding under subparagraphs 3(a) or 3(b) above, then the responsibilities of SURETY to the OWNER shall not be greater than those of the CONTRACTOR under the Contract, and the responsibilities of the OWNER to the SURETY shall not be greater than those of the OWNER under the Contract. SURETY shall be obligated to the limit of Bond Amount as set forth on the front page; subject, however, to a commitment by the OWNER for payment to the SURETY of the Balance of the Contract Price in mitigation of costs and damages on the Contract. SURETY shall be obligated, without duplication, for:

a. The responsibilities of CONTRACTOR for correction of defective or unsuitable work and performance and completion of the Contract.

b. Additional legal, design professional, and delay costs incurred by the OWNER as a result of the Contractor's Default, and as a result of SURETY'S actions or failures to act under Paragraph 5, above;

c. Liquidated damages as specified in the Contract, or, if no liquidated damages are specified in the Contract, actual damages and consequential damages incurred by the OWNER as a result of delayed performance or nonperformance of Contract by the CONTRACTOR or the SURETY; and

d. Payment of all unpaid and due and owing fees or payments owed to the OWNER under the Contract at the time of the Contractor Default.

7. To the extent of payment to the SURETY of the Balance of the Contract Price, SURETY shall defend, indemnify, and hold harmless OWNER from all claims, suits, causes of actions, and demands (including all costs of litigation and a reasonable attorney's fee), which are brought against the OWNER by the CONTRACTOR or by any other party and which arise from or by reason of payment to the SURETY the Balance of the Contract Price.

8. All notices to SURETY or CONTRACTOR shall be mailed or delivered to the respective addresses shown on the signature page. In the event of a change in address of SURETY or CONTRACTOR, such party shall promptly provide notice to the OWNER and the other party, with such notice to include the Contract number and this Performance Bond number.

9. Any provision of this Performance Bond that conflicts with the statutory or legal requirements of Michigan Public Act 213 of 1963 shall be deemed deleted here from and the provisions of such statutory or other legal requirements shall be deemed incorporated herein.

10. The law controlling the interpretation or enforcement of this Performance Bond shall be Michigan law.

11. Definitions

a. Balance of the Contract Price: The total amount payable by the OWNER to the CONTRACTOR under the Contract after all proper adjustments have been made, including change orders and credits due the OWNER, reduced by all valid and proper payments made to or on behalf of the CONTRACTOR under the Contract and reduced further by all direct costs and expenses incurred by the OWNER as a result of the Contractor Default, including costs of additional supervision or inspection by OWNER of the CONTRACTOR'S work under the Contract and fees and expenses paid to consultants or others hired by the OWNER for purposes of monitoring or investigating the CONTRACTOR'S work under the Contract.

b. Contract: The agreement between the OWNER and the CONTRACTOR identified on the front page.

c. Contractor Default: "Contractor Default" shall mean the failure or refusal of the CONTRACTOR, after written notice from the OWNER, to cure or remedy, or commence to sure or remedy, a violation of the contract within the time for such cure or remedy under the Contract. "Contractor Default" shall also mean the occurrence of an "event of default" or a "termination for cause" as those or similar terms are defined or provided for in the Contract's terms, conditions, and provisions.

Signed and Sealed This _____ day of _____, 20_____

In the Presence of: _____ *(fill-in name of contractor)*

WITNESS

Principal

Title

REQUIRED BOND LANGUAGE

WITNESS

Surety

Title

Address of Surety

Bond No.

City

Zip Code

SIGN-IN SHEET FOR MANDATORY PRE-BID MEETING FOR
 2011 SPRING LANDSCAPE PLANTING

| Company Name | Address | Representative name | Phone Number |
|----------------------------|--|---------------------|----------------------------------|
| PANORAMIC Landscaps | 40575 Grand River | Chris Cagle | 248-471-4434 |
| CHAS. F. IRISH Co INC | 24900 Groesbeck Warren mi | Chuck IRISH | 586-775-6600 Fax 586-775-7210 |
| RC Tuttle | 2475 S Hickory Ridge Saginaw MI, 48609 | Bob Sepsick | 248 361-1815 |
| Weyand Bros Inc | 10888 Swan Creek Rd | Justin Davenport | 989-781-5988 |
| B+B LANDSCAPING | 5392 PLEASANT HILL DR FENTON MI 48430 | ROBERT ANTON | 810-632-6061 |
| SALIENT Landscaping | 10302 Whittaker Rd Ypsilanti MI 48197 | Ryan Mikel | 734-337-3261 |
| Troy Clogg Landscape | 4575 Product DR, Wixom 48393 | Ken Treacher | 248 8540593 |
| M&J Cont & Landscaping inc | 3199 W. Stein rd LaSalle Mich. 48145 | William Harvzy | (734) 243-6908 |
| Marine City Nursery | 5304 Marine City Hwy China Twp Mich. 48054 | Matt Senger | 810 765 5533 |

SIGN-IN SHEET FOR MANDATORY PRE-BID MEETING FOR
2011 SPRING LANDSCAPE PLANTING

| Company Name | Address | Representative name | Phone Number |
|------------------------|---|---------------------|---------------|
| GREAT LAKES | WARREN 25512 RYAN MI 48196 | Mark Harris | 880 597-2852 |
| RELIABLE LANDSCAPE | 8285 LILLY, CANTON 48187 | BARRY WOOD | 734-455-3200 |
| BRIEN'S SERV | MILFORD 4950 TECHPICK-DR | STAN WOODRIF | 248-685-7296 |
| AMERICAN TREE | 3903 VAN DYKE ALMON, MI | KURT HENNIG | 810 798-2525 |
| Shades of Green | 446 EAST AVON RD ROCHESTER HILLS, MI 48307 | ADAM FOLK | 248.651.1620 |
| Progressive Irrigation | White Lake | Mike Doyle | 1248 789 3928 |
| Quality Landscape | 4481 Bedford | Ron Moman | 248 379 9630 |
| | | | |
| | | | |
| | | | |

**SIGN-IN SHEET FOR MANDATORY PRE-BID MEETING FOR
 2011 SPRING LANDSCAPE PLANTING**

| Company Name | Address | Representative name | Phone Number |
|--------------------------|--|---------------------|----------------|
| J & G Landscaping | 57200 Nine Mile Rd South Lyon, MI 48178 | Jeff Bell | (248) 437-6399 |
| Green Valley | 21500 24 Mile Rd Eastland Twp 48042 | Mike Sloan | (581) 634-1630 |
| | | | |
| John Deere Landscapes | 12119 Gape Rd Wolke, MI 48442 | Tom Howe | 810 836 3638 |
| | | | |
| | | | |
| | | | |
| | | | |
| | | | |
| | | | |