

City of Novi Zoning Board of Appeals Application

Attachment

September 8, 2010

Applicant: Michigan Tractor and Machine – Re: Michigan Cat

Application for variances is hereby made as related to the proposed widening of Novi Road from north of Ten Mile Road to south of Grand River Avenue. This road widening project requires the taking of a 27-foot wide strip of land along the Novi Road frontage of the Michigan Cat property, Sidwell No. 5022-23-351-059. This request closely replicates variances granted by the ZBA on May 2, 2006, Case No. 06-042.

The following variances are requested from the City of Novi Zoning and Sign Ordinances. These variances are requested pursuant to MCL 213.54 and shall run with the land, be transferable in perpetuity, and includes all alternate uses allowed by the applicable zoning district, including rebuilding or construction of a new building, and shall apply to all future uses with respect to the non-conformity created by the public taking of a portion of the property.

1. Front Yard Building Setback (Section 2400) 24800 Novi Road: A 100-foot front yard setback is required where only a 76-foot setback is provided. Therefore, a 24-foot front yard building setback variance is requested.
2. Front Parking Setback (Section 2400) 24800 Novi Road: A 100-foot setback is required for parking and only 2-feet of setback is provided. Therefore, a 98-foot front parking setback variance is requested.
3. Front Parking Setback (Section 2400) 24460 Novi Road: A 100-foot setback is required for parking and only 21-feet is provided. Therefore, a 79-foot front parking setback variance is requested.
4. Sign Variance (Section 28-5 of Ordinance 09-100.38) 24800 Novi Road: A variance to install a 23.0 foot high sign measuring 82 square feet based on the replacement of the existing 23.0 high sign measuring 82 square feet in area.
5. Sign Variance (Section 28-5 of Ordinance 09-100.38) 25000 Novi Road: A variance to install a 19.7 foot high sign measuring 108 square feet based on the replacement of the existing 19.7 foot high sign measuring 108 square feet in area.
6. Front Parking Setback (Section 2400) 25000 Novi Road: A 100-foot setback is required for parking where only 55-foot is provided. Therefore, a 45-foot front parking setback variance is requested.
7. Landscape Berm or Screen Wall, and 25-foot wide greenbelt within the Greenbelt for Right-of-way Landscape Screening (Section 2509.3b) requires a 3-foot high berm or wall when adjacent to parking and a 25-foot wide greenbelt landscape area. Such a waiver was granted on May 2, 2006, for 24800 Novi Road, 24460 Novi Road and 25000 Novi Road. These variances are requested again with the aforementioned language that they shall run with the land in perpetuity.
8. Outdoor Storage/Display Area for Heavy Machinery (Section 2001.3) 24800 Novi Road: A variance was granted on May 2, 2006, for the continuation of the existing outdoor storage/display of heavy machinery in the front yard; and the elimination of the screen wall or landscaped berm for the outdoor storage/display. These variances are requested again with the aforementioned language that they shall run with the land in perpetuity.

Item 9. Statement of practical difficulties which prevent conformance with the Zoning Ordinance requirements.

The practical difficulties standard provides relief for the above dimensional standards for the following reasons:

1. The property owner would incur a severe hardship for its business, after the Novi Road widening, if the building, parking, signage, landscape and display areas are deemed to be non-conforming. This would result in difficulty in acquiring loans from financial institutions.
2. No modifications to the property could be made in the future without a variance.
3. Not granting the requested variances would present a substantial detriment to the overall public good. The Road Commission for Oakland County would likely not be able to acquire the right-of-way necessary to widen Novi Road, or would result in substantially higher land owner compensation. Such a cost would present a burden to the taxpaying public.

Item 10. Describe any unique circumstances regarding the property which are not common to other properties in the area and which prevent strict compliance with the Zoning Ordinance.

1. The granting of the listed variances will not impair the intent of the ordinance. The character of the area will not change. The road construction will simply move the traveled portion of Novi Road closer to the existing parking and buildings.
2. By not granting the variances there may also exist a safety issue related to an increase of hazards with the roadway unable to provide necessary traffic load capacities.
3. The circumstance is unique since the property owner is not the cause of the need for variances. Rather it is the result of a governmental agency taking a portion of the property by eminent domain for a public improvement.

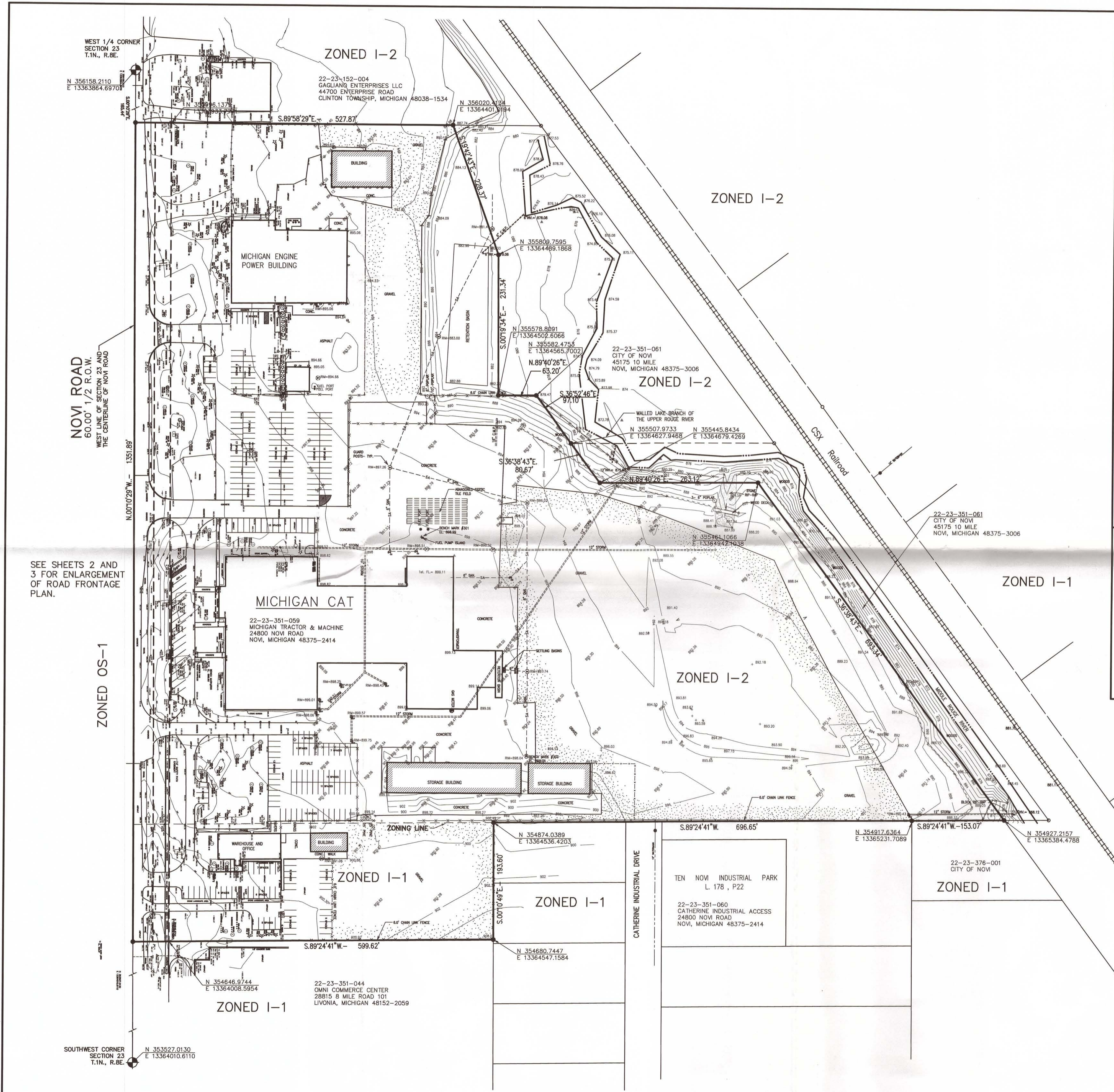

- ### LEGEND
- BUILDING
 - ASPHALT
 - CONCRETE
 - GRAVEL
 - STORM
 - SANITARY
 - WATERMAIN
 - GAS
 - UND. TELEPHONE
 - UND. ELECTRICAL
 - TRaverse LINE & TRAVERSE POINT
 - BENCH MARK SYMBOL
 - DEAD TREE
 - DECIDUOUS TREE
 - DECIDUOUS SHRUB
 - CONIFEROUS TREE
 - CONIFEROUS SHRUB
 - STUMP
 - SQ. & RD. CATCH BASINS & INLETS IN PAVEMENT
 - STORM MANHOLE & PIPE END
 - UNSPECIFIED MH
 - RISER & DOWN SPOUT
 - PUMP STATION
 - FIRE HYDRANT
 - GATE & VALVE, & WELL
 - CISTERN & WELL
 - WATER STOP BOX & SPRINKLER HEAD
 - WATER TOWER BASE & METER PIT
 - UTILITY POLE
 - LIGHT POLE
 - GUY WIRE ANCHOR
 - UNDERGROUND MARKER
 - RISER
 - GAS BOX & BLOW OFF
 - BUILD CORNER & 1st FLOOR ELEV.
 - EDGE OF DITCH
 - TOE OF SLOPE
 - TOP OF BANK & RIDGE
 - TOP OF BERM
 - TOE OF BERM
 - EDGE OF WATER
 - WATER SURFACE
 - HEADWALL & RETAINING WALL
 - SIGNS & SIGN POST
 - LOCAL LOW POINT & LOCAL HIGH POINT

- ### BENCHMARKS
- BENCHMARK #300 - NW CORNER CONC. ON FLAG POLE BASE IN FRONT OF MICHIGAN CAT BLDG. ELEVATION = 898.90 USGS DATUM
 - BENCHMARK #301 - NW CORNER CONC. SLAB AROUND GAS PUMP @ NW CORNER MAIN GARAGE. ELEVATION = 898.99 USGS DATUM
 - BENCHMARK #303 - NORTH RIM MANHOLE 100' SOUTHEAST OF SE. MOST CORNER OF MAIN GARAGE. ELEVATION = 898.04 USGS DATUM
 - BENCHMARK #306 - PK. NAIL EAST FACE P. POLE WEST SIDE NOVI ROAD 50' S. OF S. ENTRANCE TO MICHIGAN CAT. ELEVATION = 892.37 USGS DATUM

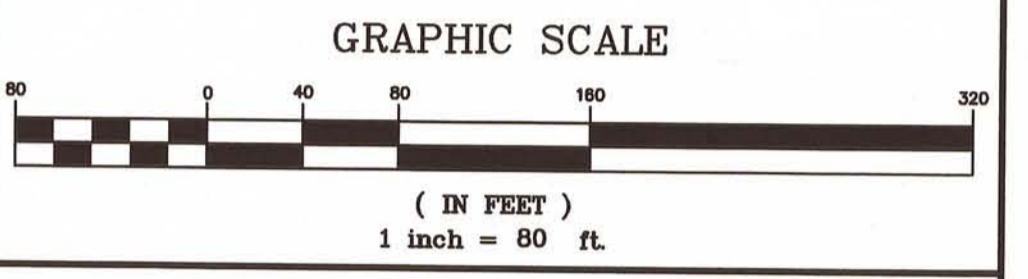
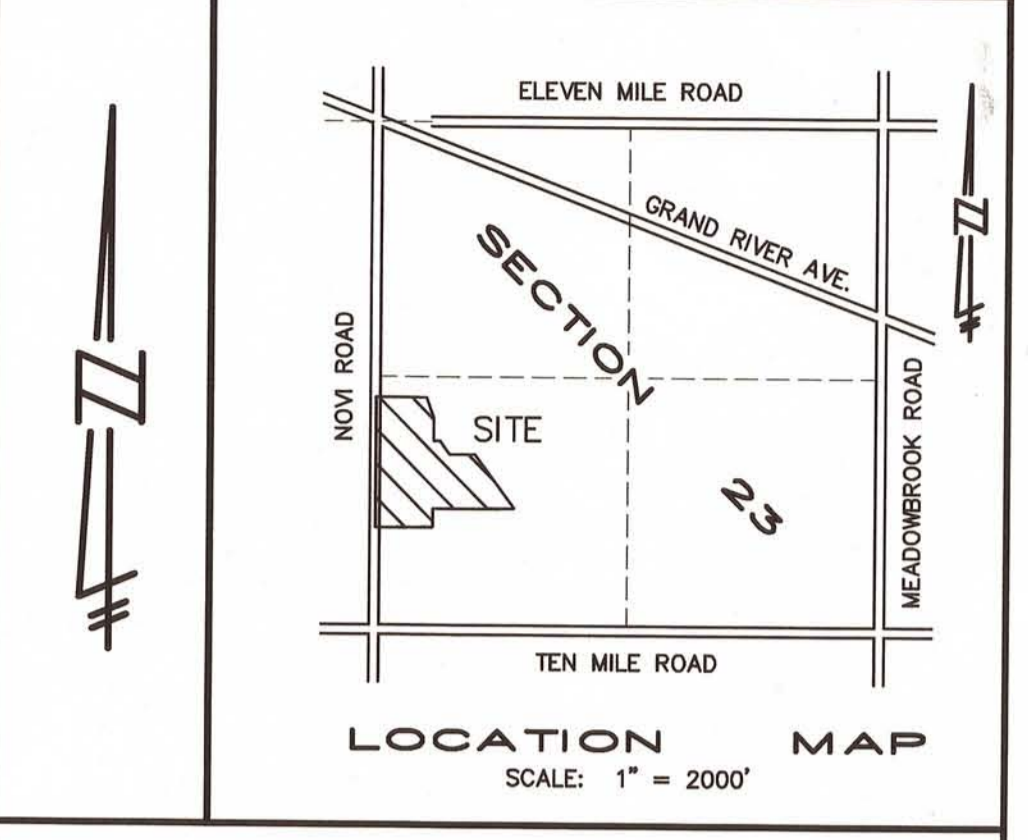

Subject Property
Legal Description

A part of the Southwest 1/4 of Section 23, Town 1 North, Range 8 East, City of Novi, Oakland County, Michigan; being more particularly described as commencing at the West 1/4 Corner of said Section 23; thence South 00°10'29" East, 165.44 feet, along the West line of said Section 23 and the centerline of Novi Road, to the Point of Beginning; thence South 89°58'29" East, 527.87 feet; thence South 10°42'43" East, 225.37 feet; thence South 00°19'34" 231.34 feet; thence North 89°40'26" East, 63.20 feet; thence South 36°52'46" East, 97.10 feet; thence South 36°38'43" East, 80.67 feet; thence North 89°40'26" East, 263.12 feet; thence South 36°38'43" East, 693.34 feet, (recorded as 694.15 feet; thence South 89°24'41" West, 153.07 feet, (by extension of the North line of "Ten-Nowi Industrial Park", as recorded in Liber 178 of Plats, on Page 22, Oakland County Records), to the Northeast corner of said "Ten-Nowi Industrial Park"; thence continuing South 89°24'41" West, 696.65 feet, along the North line of said "Ten-Nowi Industrial Park" to the Northwest corner of said "Ten-Nowi Industrial Park"; thence South 00°10'49" East, 193.60 feet; thence South 89°24'41" West, 599.62 feet, to the West line of Section 23 and the centerline of said Novi Road; thence North 00°10'29" West, 1351.89 feet, along the West line of said Section 23 and the centerline of said Novi Road, to the Point of Beginning. All of the above containing 27.116 Acres. All of the above being subject to easements, restrictions and right-of-ways of record. All of the above being subject to the rights of the public in Novi Road.

Safety Path Easement
Legal Description

The East 7.00 feet of the West 60.00 feet of the South 340.00 feet of the above described parcel.

NOTE:
 Bearings are based on the J.C.K. property split survey, dated 08-04-92, and recorded in Liber 12938, on Pages 431 through 434, Oakland County Records.

SHEET INDEX

1	COMPOSITE SITE PLAN
2	IMPROVEMENT PLAN - NOVI ROAD FRONTAGE - NORTH
3	IMPROVEMENT PLAN - NOVI ROAD FRONTAGE - SOUTH

OWNER:
 Michigan Tractor & Machine
 24800 Novi Road
 Novi, Michigan 48375
 PH: 810.349.4800

MICHIGAN CAT
 SECTION 23, TOWN 1 NORTH, RANGE 8 EAST
 CITY OF NOVI, OAKLAND COUNTY, MICHIGAN

REVISIONS		ENGINEER'S SEAL	
NO.	ITEM	DATE	

DATE: 06-11-10 DESIGNED BY: CS CHECKED BY: CS JOB NUMBER: 10-016

PRELIMINARY SITE PLAN
COMPOSITE EXISTING CONDITIONS PLAN

MILLETICS AND ASSOCIATES, L.L.C.
 LAND SURVEYORS
 40000 GRAND RIVER AVENUE • SUITE 206 • NOVI, MI • 48375-2110
 248.473.7880

SEIBER ENGINEERING, P.L.L.C. SHEET 1
 CIVIL ENGINEER
 8145 BENNY LANE • WHITE LAKE, MI • 48386-3507
 248.231.9036

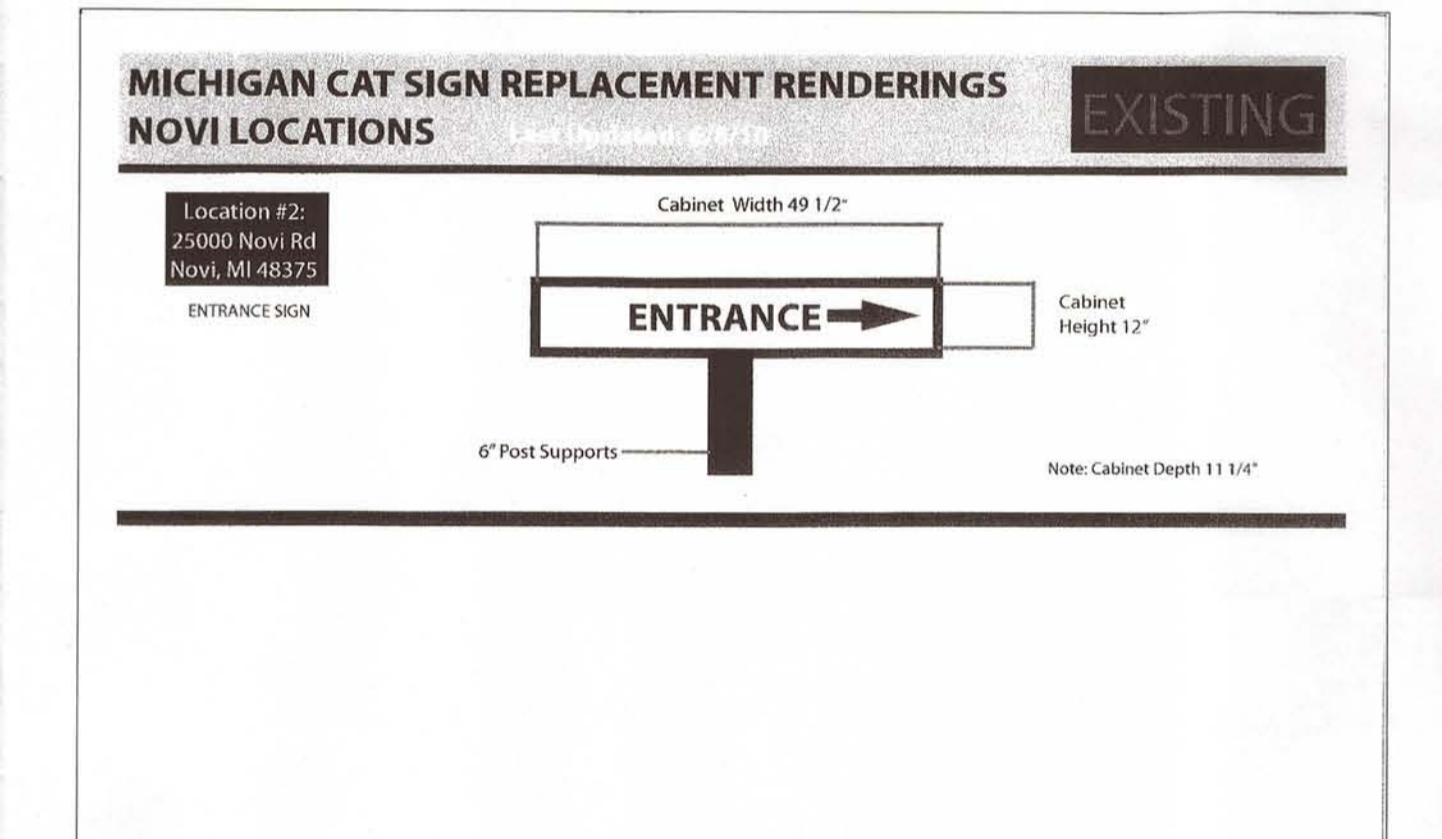
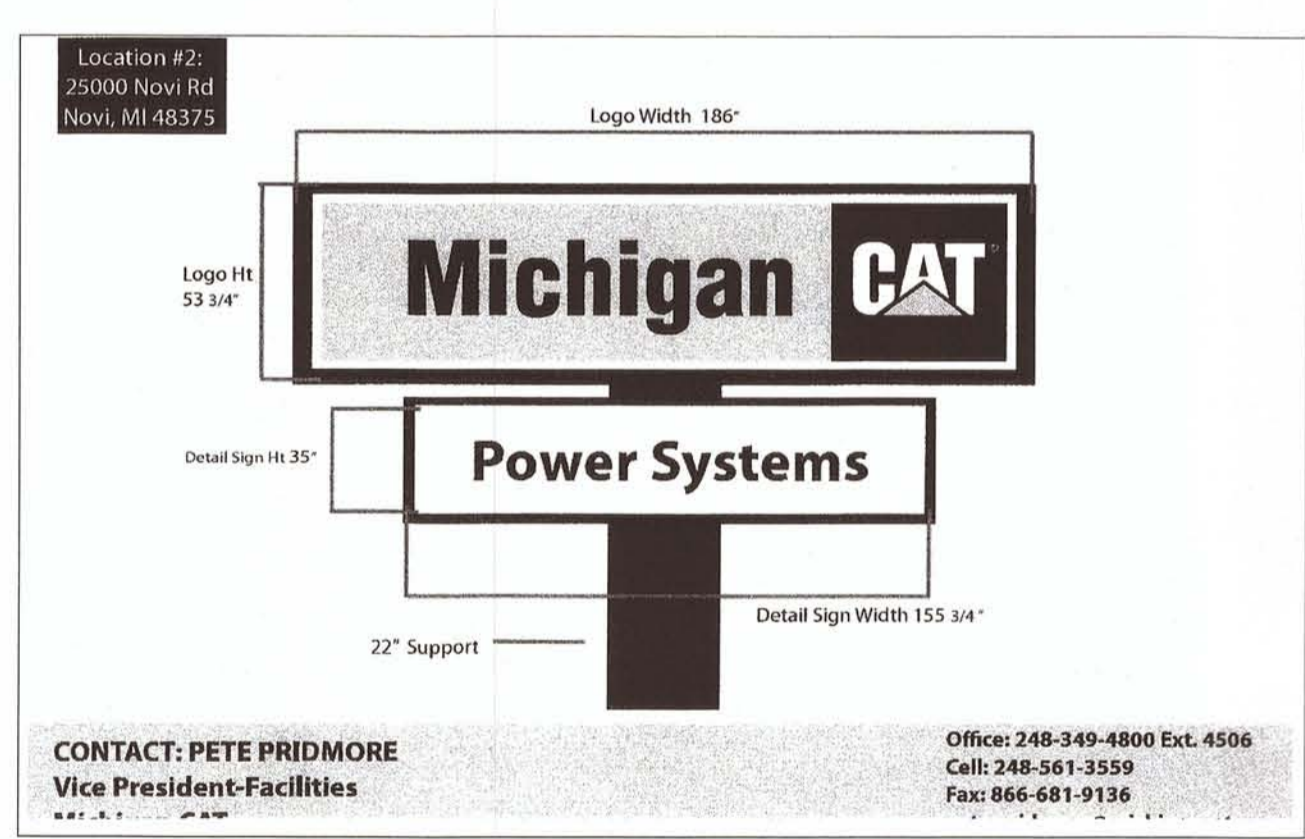
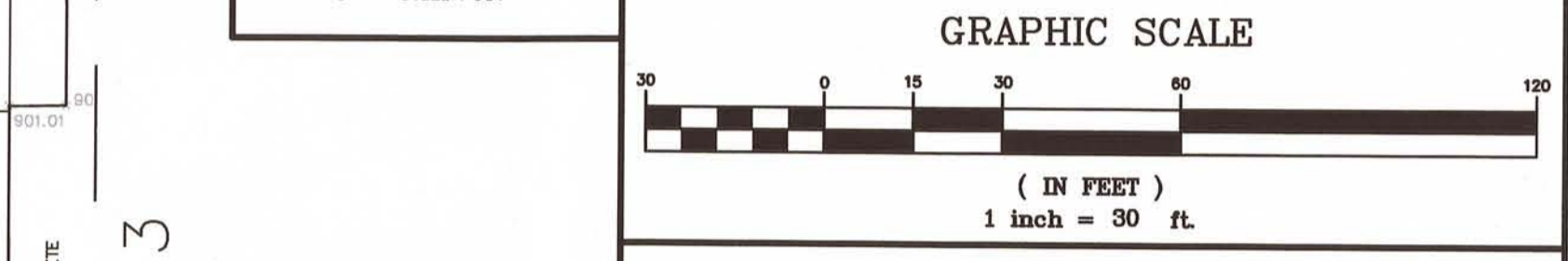
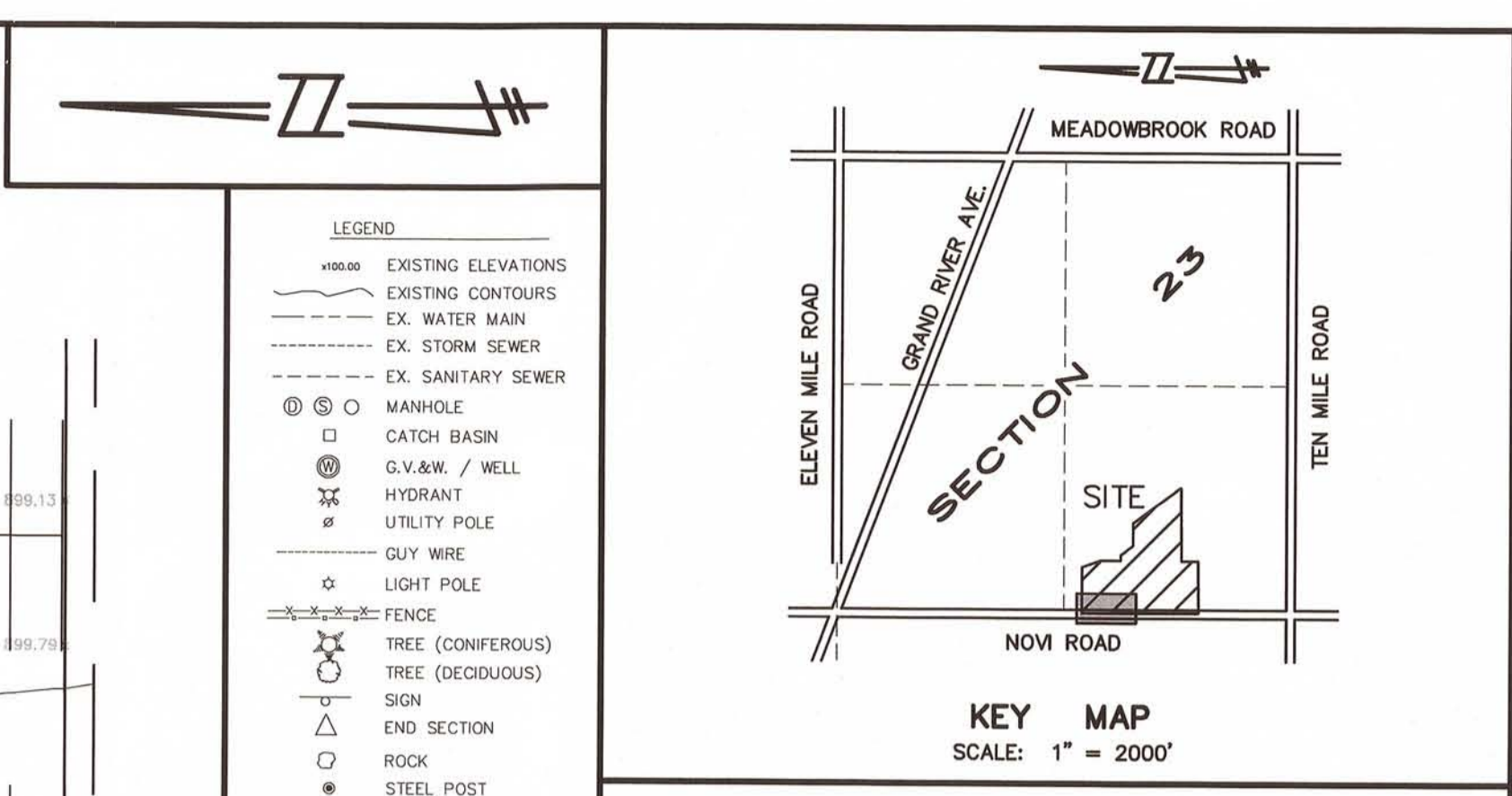
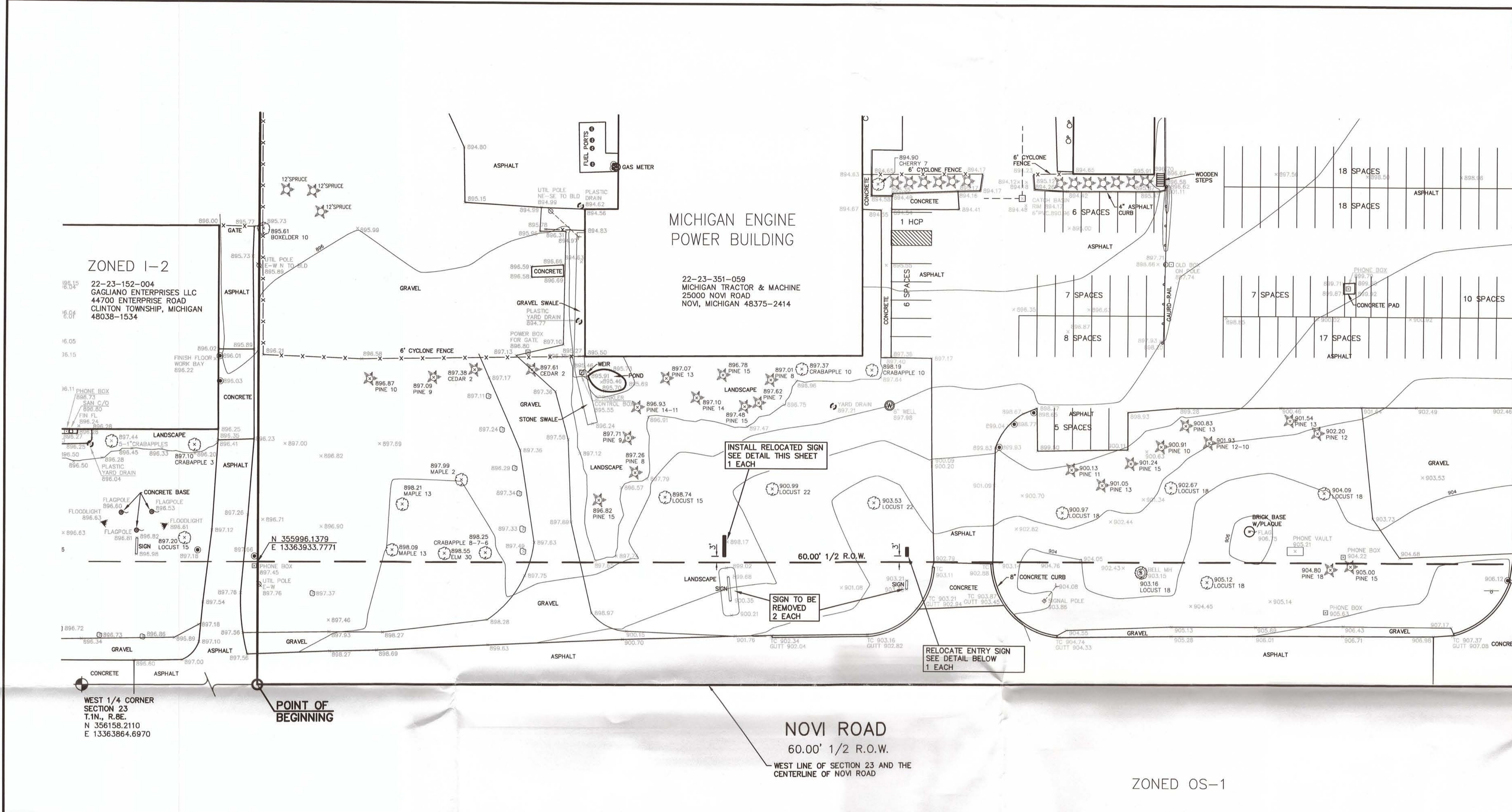

MICHIGAN CAT
SECTION 23, TOWN 1 NORTH, RANGE 8 EAST
CITY OF NOVI, OAKLAND COUNTY, MICHIGAN

REVISIONS		
NO.	ITEM	DATE

ENGINEER'S SEAL
 STATE OF MICHIGAN
 CLIF SEIBER
 ENGINEER
 No. 31672
 LICENSED PROFESSIONAL ENGINEER

DATE: 06-07-10 DESIGNED BY: CS CHECKED BY: CS
 JOB NUMBER: 10-016

IMPROVEMENT PLAN
NOVI ROAD FRONTAGE - NORTH

MILLETICS AND ASSOCIATES, L.L.C.
LAND SURVEYORS
4000 GRAND RIVER AVENUE • SUITE 206 • NOVI, MI • 48375-2110
248-473-7880

SEIBER ENGINEERING, P.L.L.C. SHEET 2
CIVIL ENGINEER
8145 BENNY LANE • WHITE LAKE, MI • 48386-3507
248.231.9036

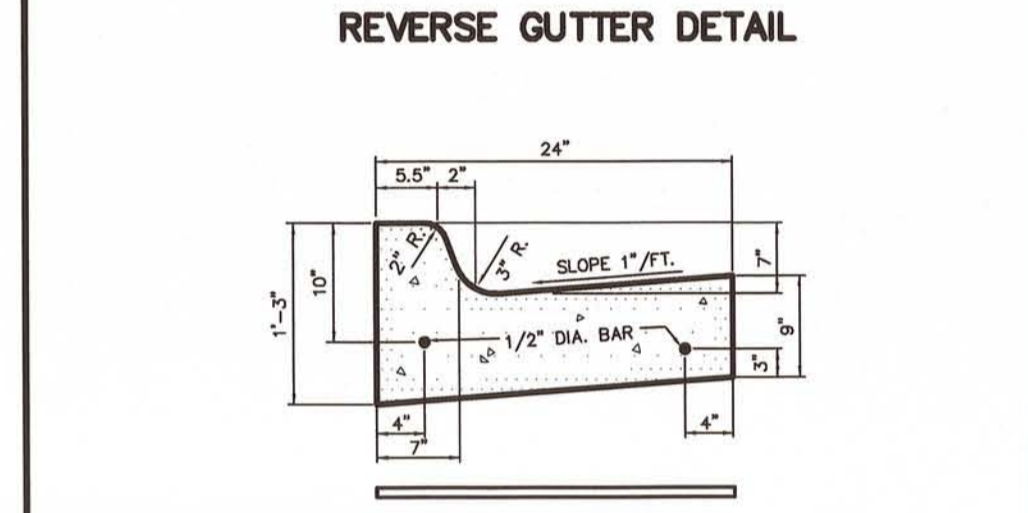
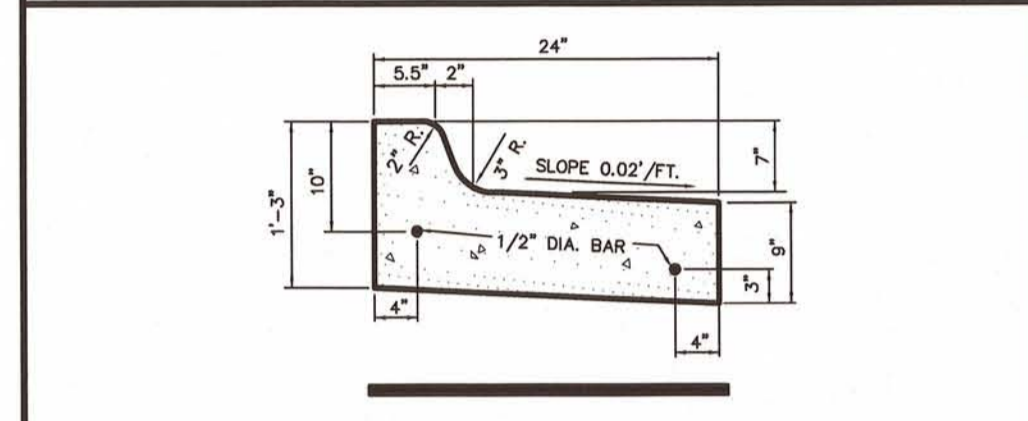
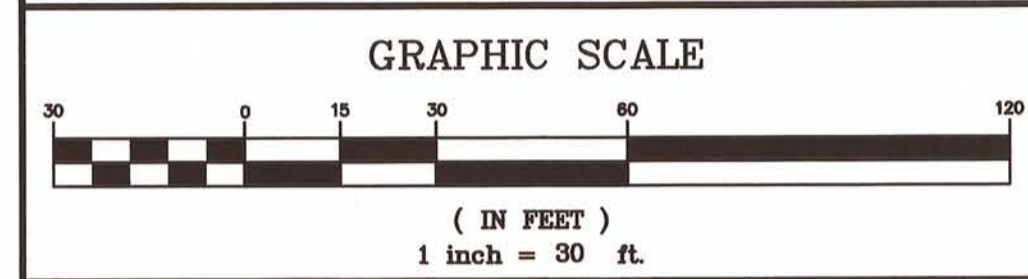
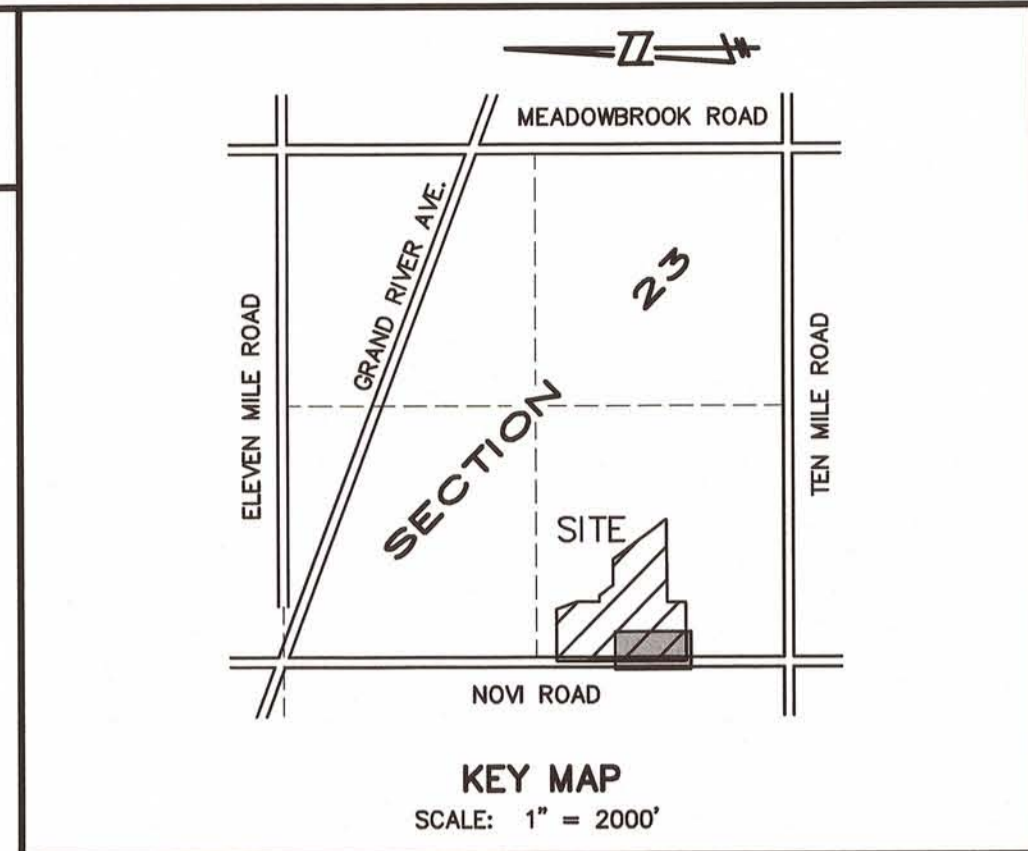
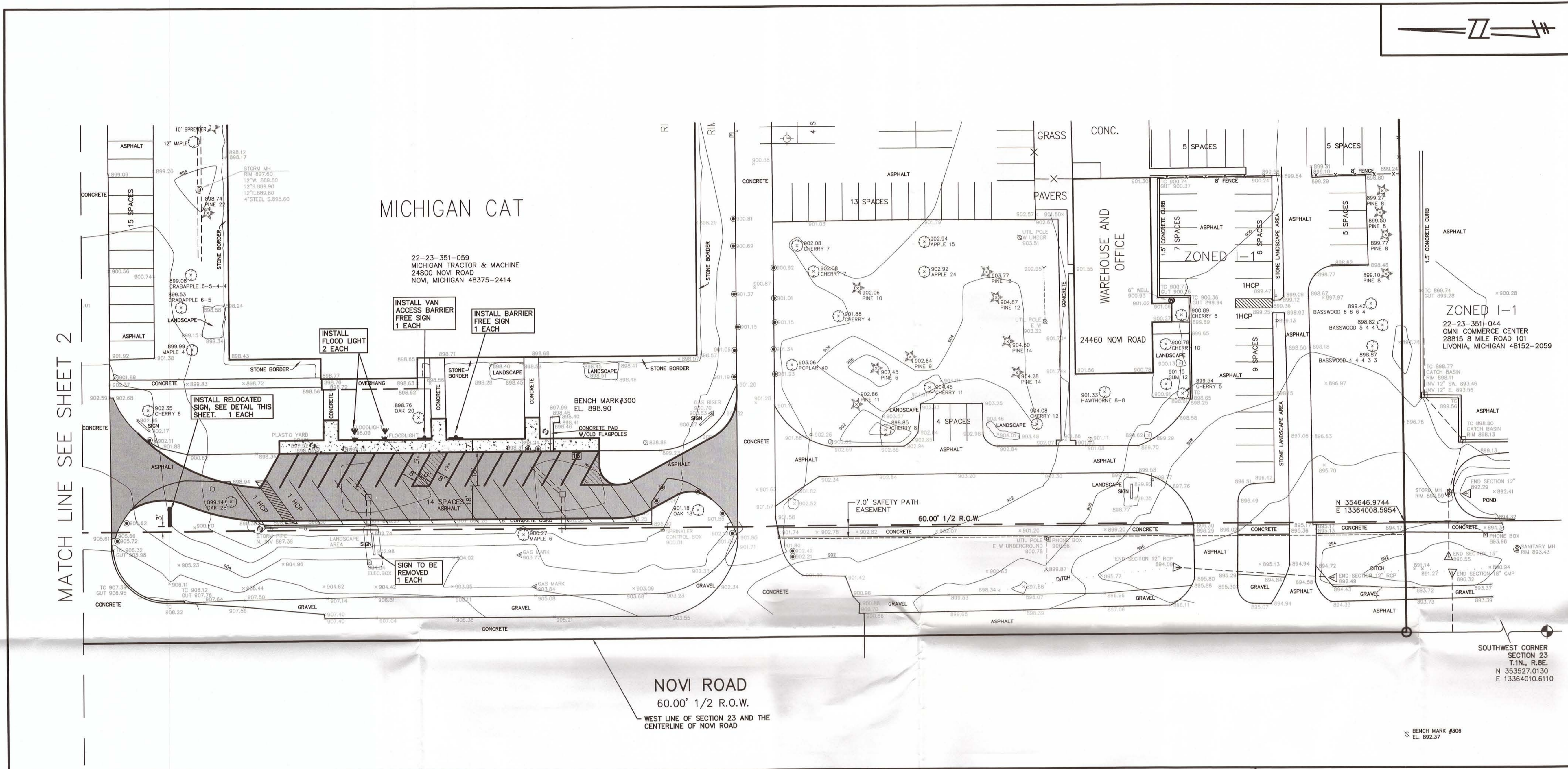

M.D.O.T. C-4 STRAIGHT FACE
CONCRETE CURB AND GUTTER

MATCH LINE SEE SHEET 2

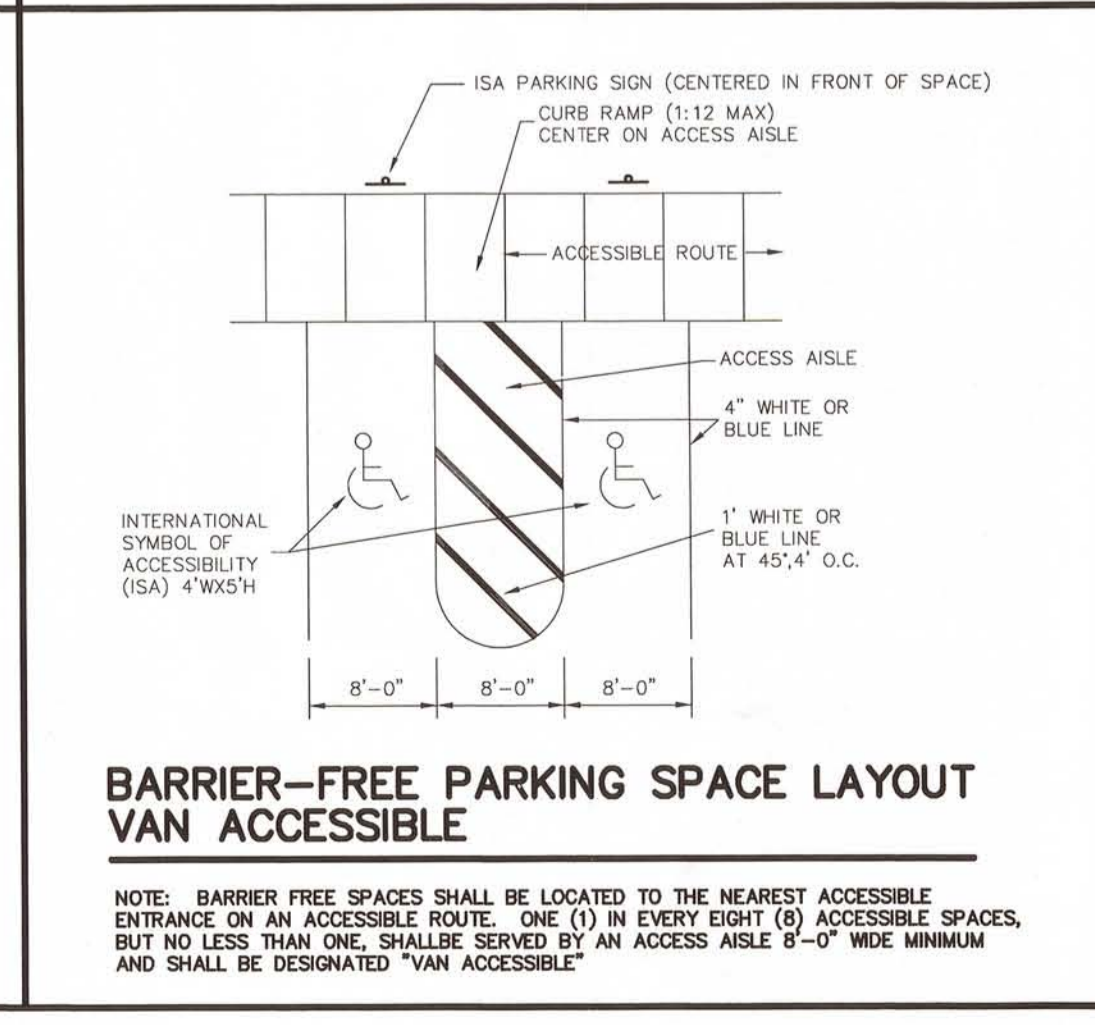
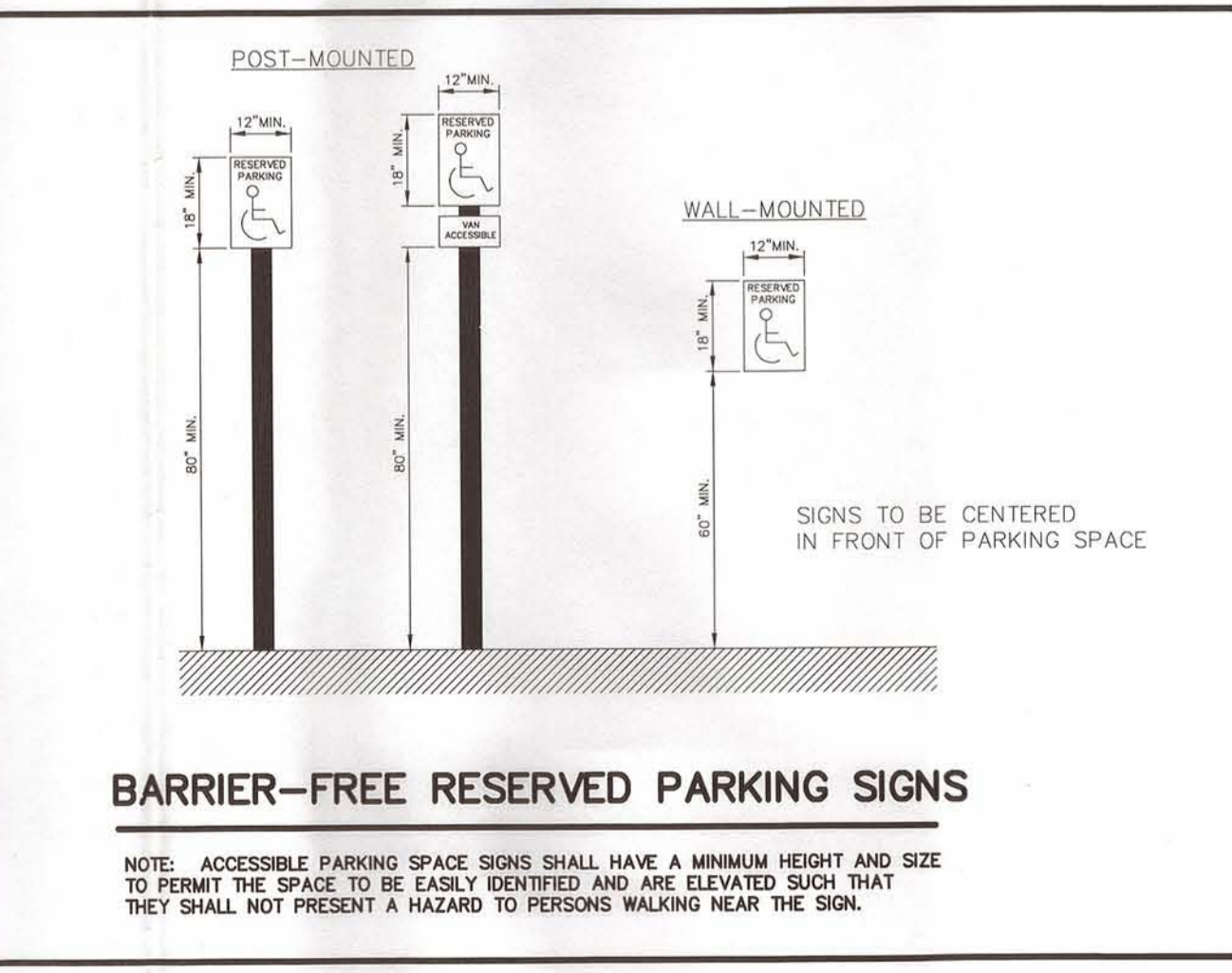
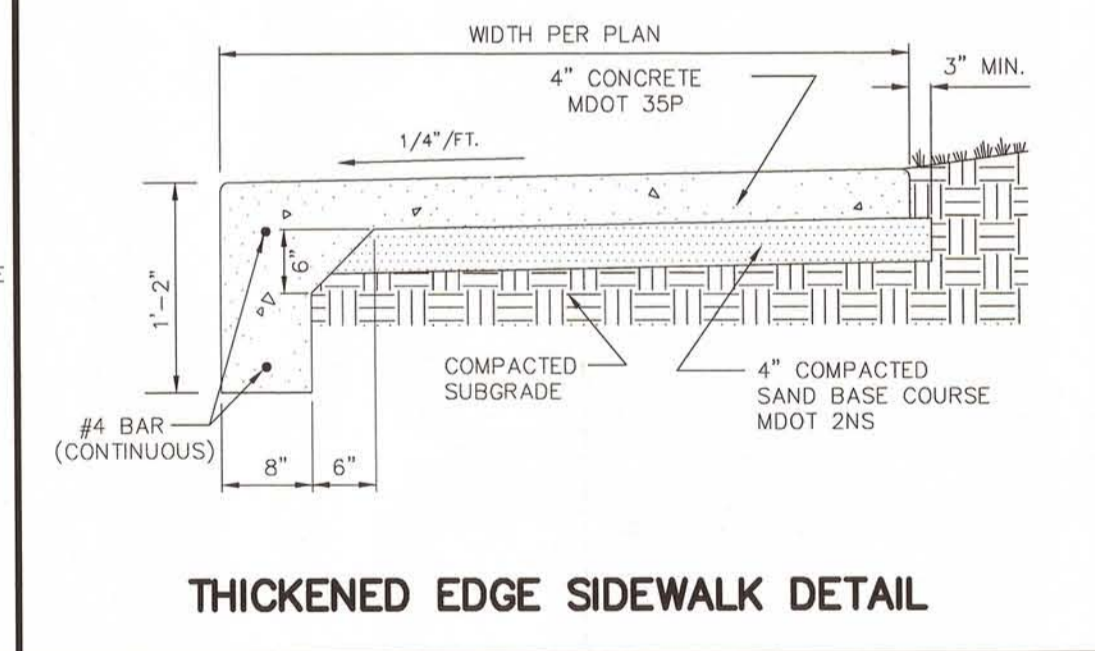
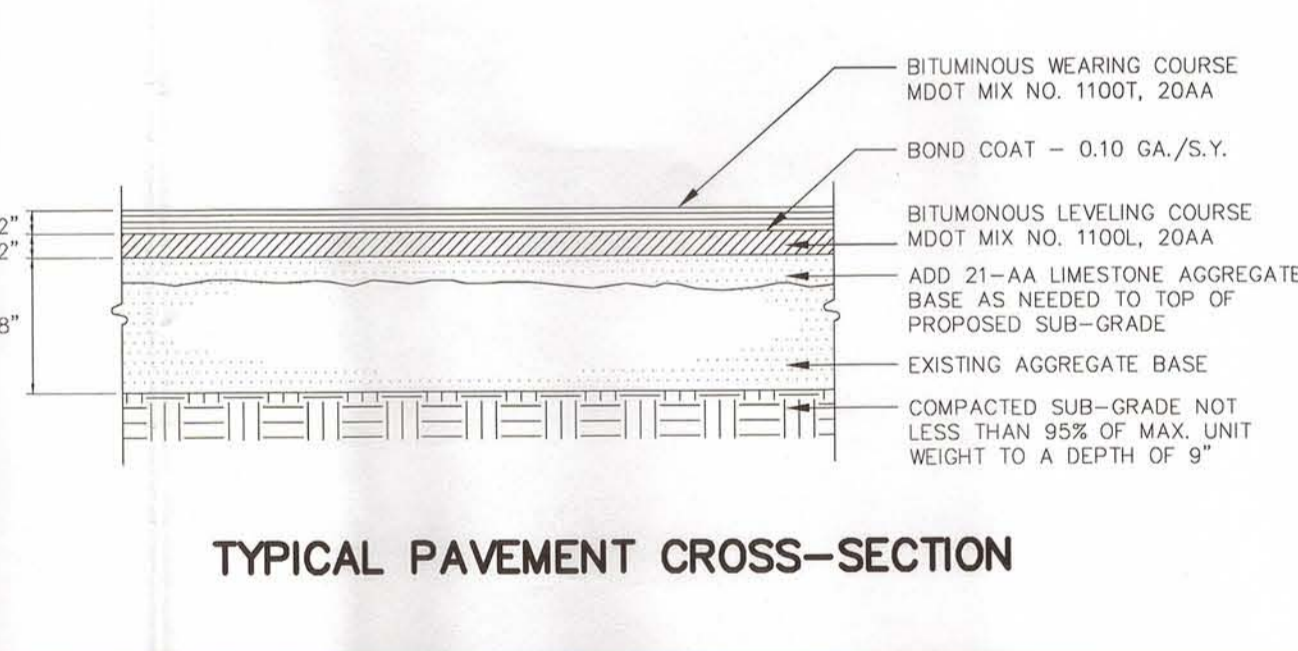
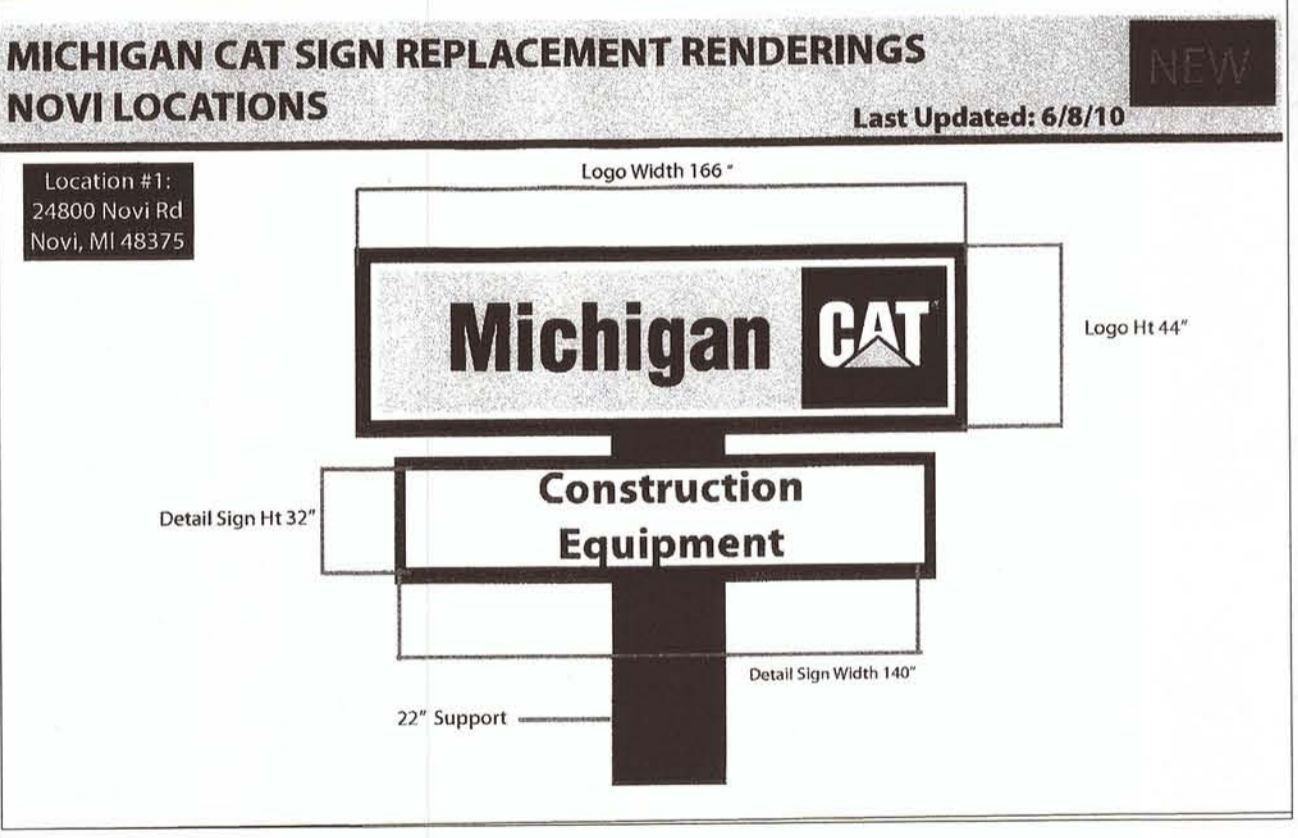

MICHIGAN CAT
SECTION 23, TOWN 1 NORTH, RANGE 8 EAST
CITY OF NOVI, OAKLAND COUNTY, MICHIGAN

REVISIONS			ENGINEER'S SEAL
NO.	ITEM	DATE	

DATE: 06-07-10 DESIGNED BY: CS CHECKED BY: CS JOB NUMBER: 10-016

IMPROVEMENT PLAN
NOVI ROAD FRONTAGE - SOUTH

MILLETICS AND ASSOCIATES, L.L.C.
LAND SURVEYORS
40000 GRAND RIVER AVENUE • SUITE 206 • NOVI, MI • 48375-2110
248.473.7880

SEIBER ENGINEERING, P.L.L.C. SHEET
CIVIL ENGINEER
8145 BENNY LANE • WHITE LAKE, MI • 48386-3507
248.231.9036 3