



**CITY OF NOVI CITY COUNCIL
JUNE 21, 2021**

SUBJECT: Acceptance of two donated storm sewer easements as part of the Cranbrooke Road Reconstruction project from Nine Mile Road to Village Wood Road.

SUBMITTING DEPARTMENT: Department of Public Works, Engineering Division

BACKGROUND INFORMATION: The 2021 Cranbrooke Road Reconstruction project will include road work, sidewalk construction, and drainage improvements between Nine Mile Road and Village Wood Road. Three temporary grading easements and two permanent storm sewer easements are required from the Lakewood Parkhomes Condominium Association for the sidewalk construction and drainage improvements. All easements have been donated to the City by Lakewood Parkhomes.

The proposed easements have been favorably reviewed by the City Attorney (Beth Saarela, June 8, 2021). Construction will begin in July of 2021.

RECOMMENDED ACTION: Acceptance of two donated storm sewer easements as part of the Cranbrooke Road Reconstruction project from Nine Mile Road to Village Wood Road.

Cranbrooke Drive Storm Sewer Easements Location Map

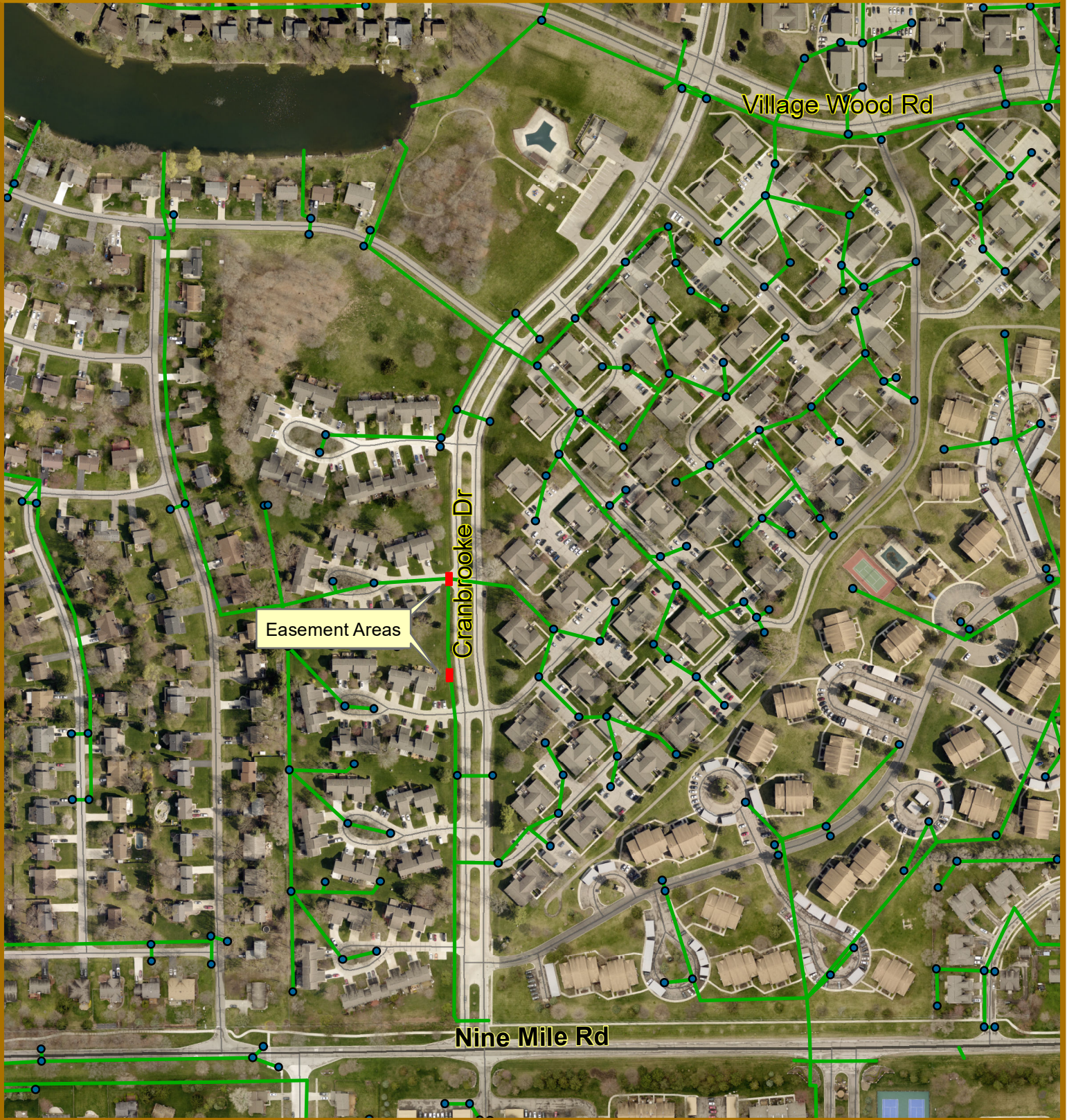

Map Author: Rebecca Runkel
Date: 5-25-21
Project: Cranbrooke Rd Easements
Version #: 1.0

MAP INTERPRETATION NOTICE

Map information depicted is not intended to replace or substitute for any official or primary source. This map was intended to meet National Map Accuracy Standards and use the most recent, accurate sources available to the people of the City of Novi. Boundary measurements and area calculations are approximate and should not be construed as survey measurements performed by a licensed Michigan Surveyor as defined in Michigan Public Act 132 of 1970 as amended. Please contact the City GIS Manager to confirm source and accuracy information related to this map.

Legend

- Catch Basin
- Stormwater Gravity Main

		04	03	02	01
		09	10	11	12
18	17	16	15	14	13
19	20	21	22	23	24
30	29	28	27	26	25
31	32	33	34	35	36



City of Novi
Engineering Division
Department of Public Works
26300 Lee BeGole Drive
Novi, MI 48375
cityofnovi.org



ELIZABETH KUDLA SAARELA
esaarela@rsjalaw.com

27555 Executive Drive, Suite 250
Farmington Hills, Michigan 48331
P 248.489.4100 | F 248.489.1726
www.rsjalaw.com



ROSATI | SCHULTZ
JOPPICH | AMTSBUECHLER

June 8, 2021

Jeffrey Herczeg, Director of Public Works
City of Novi
Field Services Complex
26300 Lee BeGole Drive
Novi, MI 48375

**RE: Cranbrooke Drive Reconstruction
Storm Sewer Easements**

Dear Mr. Herczeg:

We have received and reviewed two (2) final executed Storm Sewer Easements over property owned by the Lakewood Parkhomes Condominium Association required for the Cranbrooke Drive Reconstruction Project. The Storm Sewer Easements were donated by the Association. The Storm Sewer Easements provided are in the City's standard format for ongoing maintenance, repair and/or replacement of storm sewer facilities and are consistent with the title search for the property.

The Storm Sewer Easements may be placed on an upcoming City Council Agenda for acceptance. Once accepted, they should be recorded by the City Clerk's Office with the Oakland County Register of Deeds in the usual manner. It is our understanding that the City's Engineering Division has the original Storm Sewer Easements for recording.

Please feel free to contact me with any questions or concerns in regard to this matter.

Very truly yours,

ROSATI SCHULTZ JOPPICH
& AMTSBUECHLER PC

Elizabeth Kudla Saarela

EKS
Enclosures

Jeffrey Herczeg, Director of Public Works
City of Novi
June 8, 2021
Page 2

C: Cortney Hanson, Clerk (w/ Enclosures)
Ben Croy, City Engineer (w/Enclosures)
Rebecca Runkel, Staff Engineer (w/Enclosures)
Thomas R. Schultz, Esquire (w/Enclosures)

STORM SEWER EASEMENT

KNOW ALL MEN BY THESE PRESENTS, that LAKEWOODE PARKHOMES CONDOMINIUM ASSOCIATION a Michigan nonprofit corporation, whose address is 23131 Cranbrooke Dr., Novi, MI 48375, (hereinafter referred to as "Grantor"), being title holder to the following described parcel of land, to-wit:

[See attached and incorporated Exhibit A]

Tax Identification Number: 50-22-25-412-001

for and in consideration of One (\$1.00) Dollar, receipt and sufficiency of which is hereby acknowledged, does hereby grant and convey to the City of Novi, a Michigan municipal corporation, whose address is 45175 Ten Mile, Novi, Michigan 48375, (hereinafter referred to as "Grantee"), a nonexclusive perpetual easement for storm sewer, over, upon, across, in, through, and under the following described real property, to-wit:

[See attached and incorporated Exhibit B]

and to enter upon sufficient land adjacent to said storm sewer easement for the purpose of exercising the rights and privileges granted herein.

Grantee may install, repair, replace, improve, modify and maintain the storm sewer lines, and all necessary appurtenances thereto, within the easement herein granted.

Grantor agrees not to build or to convey to others permission to build any permanent structures on, over, across, in, through, or under the above-described easement, except that, subject to Grantee's approval as part of an approved site plan, the Grantor may construct and/or install surface improvements to the property, including paved driveways, parking and/or walkways; landscaping; utilities and/or similar improvements, which improvements do not interfere with use, operation, maintenance, repair and replacement of the storm sewer in the easement areas shown on the attached and incorporated Exhibit B.

This instrument shall run with the land first described above and shall be binding upon and inure to the benefit of the Grantor, Grantee, and their respective heirs, representatives, successors and assigns.

IN WITNESS WHEREOF, the undersigned Grantor has affixed his signature this day of June 2, 2021.

GRANTOR:

LAKEWOODE PARKHOMES CONDOMINIUM ASSOCIATION, a Michigan nonprofit corporation,

By: Curt Lind BOARD PRESIDENT
Curt Lind Its:

STATE OF MICHIGAN)

)SS

COUNTY OF OAKLAND)

On this 2 day of June, 2021, before me, personally appeared the above named Curt Lind, the President of Lakewood Parkhomes, to me known to be the person described in and who executed the foregoing instrument and acknowledged that they executed the same as his free act and deed.



[Signature]
Notary Public
Oakland County, MI
My commission expires 1/25/24

THIS INSTRUMENT DRAFTED BY:

Elizabeth K. Saarela, Esquire
ROSATI SCHULTZ JOPPICH & Amtsbuechler, P.C.
27555 Executive Drive, Suite 250
Farmington Hills, Michigan 48331
AND WHEN RECORDED RETURN TO:

Cortney Hanson, Clerk
45175 Ten Mile
Novi, Michigan 48375

EXHIBIT A - PROPERTY DESCRIPTION SEGMENT 24

PART OF THE SOUTHEAST $\frac{1}{4}$ OF SECTION 25, T.1N., R.8E., CITY OF NOVI, OAKLAND COUNTY, MICHIGAN
THE LAND REFERRED TO IS DESCRIBED AS FOLLOWS: CITY OF NOVI, COUNTY OF OAKLAND, STATE OF MICHIGAN

PART OF THE SOUTHEAST QUARTER OF SECTION 25, TOWN 1 NORTH, RANGE 8 EAST, CITY OF NOVI, OAKLAND COUNTY, MICHIGAN BEGINNING AT THE S. $\frac{1}{4}$ CORNER OF SAID SECTION 25; THENCE N00°08'54"W., 925.56 FEET ALONG THE NORTH AND SOUTH $\frac{1}{4}$ LINE OF SAID SECTION 25; THENCE N89°51'06"E., 212.10 FEET TO THE POINT OF BEGINNING; THENCE N07°07'49"W., 89.64 FEET; THENCE N11°21'02"W., 99.63 FEET; THENCE N18°49'57"W., 97.89 FEET; THENCE N88°05'46"E., 434.16 FEET; THENCE ALONG THE ARC OF A CURVE TO THE LEFT, RADIUS 543.00 FEET, CENTRAL ANGLE 02°49'46", CHORD 26.81 FEET; CHORD BEARING S01°24'53"E, A DISTANCE OF 26.81 FEET; THENCE S02°49'46"E., 100.00 FEET; THENCE ALONG THE ARC OF A CURVE TO THE RIGHT, RADIUS 457.00 FEET, CENTRAL ANGLE 02°49'46" CHORD 22.57 FEET; CHORD BEARING S01°24'53"E., A DISTANCE OF 22.57 FEET; THENCE S00°00'00"E., 125.39 FEET; THENCE S87°06'37"W., 378.23 FEET TO THE POINT OF BEGINNING AND CONTAINING 2.56 ACRES

COPYRIGHT © 2018, All Rights Reserved

AECOM

UTILITY
EASEMENT
NOVI, MI

SURVEY FOR:

CITY OF NOVI
DATE: 03/09/2021
JOB NO. : 63636546
DRAWN: AECOM
CHECKED BY: AECOM

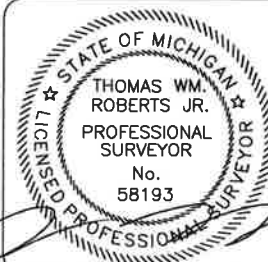
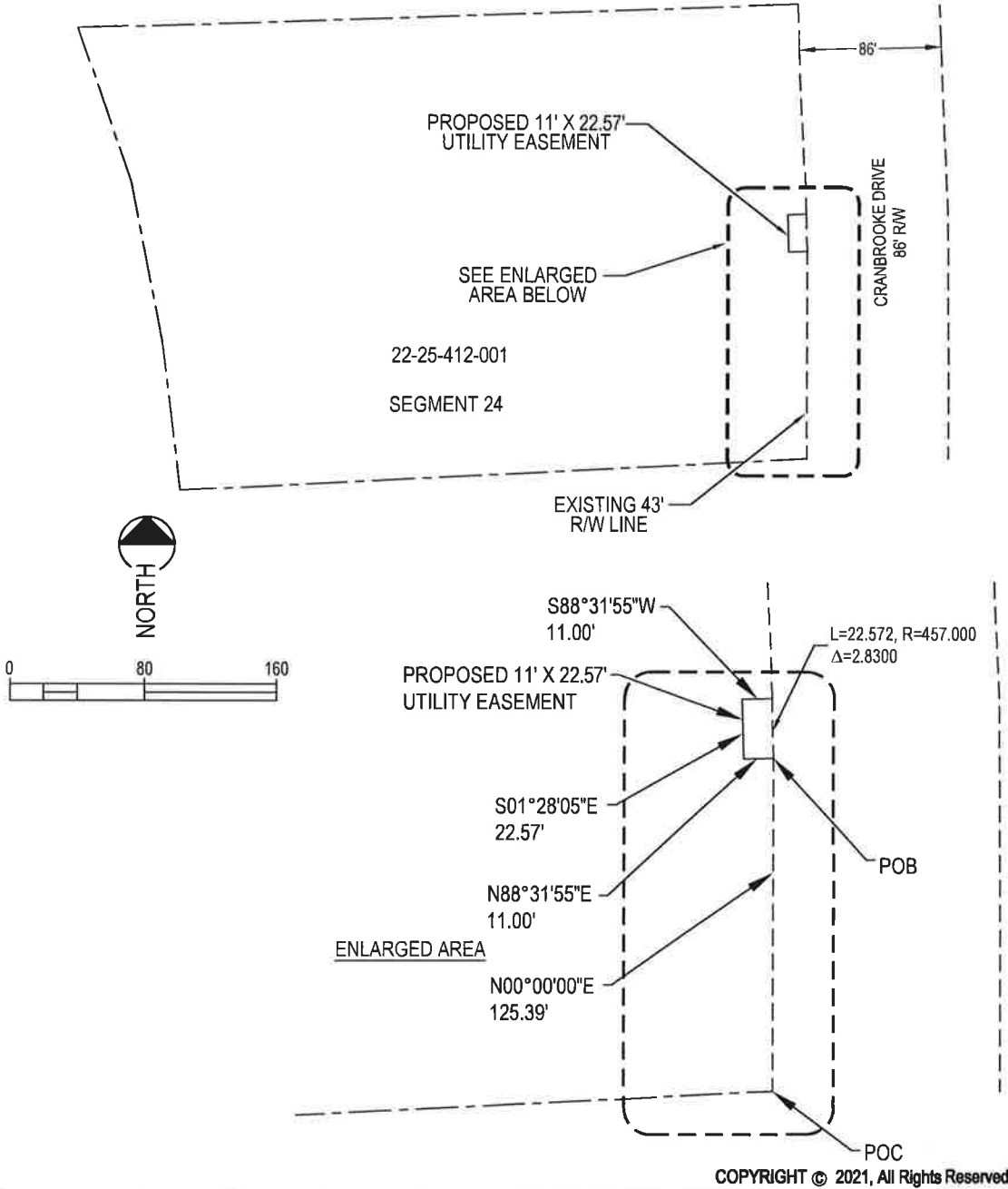

EXHIBIT B - UTILITY EASEMENT

PROPOSED 11' X 22.57' WIDE UTILITY EASEMENT DESCRIPTION:

COMMENCING FROM THE S.E CORNER OF SEGMENT 24; THENCE N00°00'00"E 125.39 FEET TO THE POINT OF THE BEGINNING OF A 11' X 22.57' UTILITY EASEMENT; THENCE ALONG THE ARC OF A CURVE TO THE LEFT, RADIUS 457.00 FEET, CENTRAL ANGLE 02°49'46", CHORD 22.57 FEET; CHORD BEARING N01°24'53"W., A DISTANCE OF 22.57 FEET; THENCE S88°31'55"W., 11.00 FEET; THENCE S01°28'05"E., 22.57 FEET; THENCE N88°31'55"E 11.00 FEET BACK TO THE POINT OF BEGINNING CONTAINING 248 SQUARE FEET MORE OR LESS.



COPYRIGHT © 2021, All Rights Reserved

UTILITY EASEMENT
NOVI, MI

SURVEY FOR:
CITY OF NOVI
DATE: 03/09/2021
JOB NO. : 60636546
DRAWN: AECOM
CHECKED BY: AECOM

LEGEND

PARENT PARCEL

EXISTING R/W LINE

PROPOSED EASEMENT

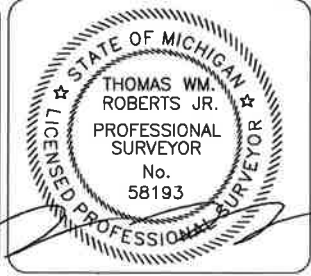

STORM SEWER EASEMENT

KNOW ALL MEN BY THESE PRESENTS, that LAKEWOODE PARKHOMES CONDOMINIUM ASSOCIATION a Michigan nonprofit corporation, whose address is 23131 Cranbrooke Dr., Novi, MI 48375, (hereinafter referred to as "Grantor"), being title holder to the following described parcel of land, to-wit:

[See attached and incorporated Exhibit A]

Tax Identification Number: 50-22-25-412-001

for and in consideration of One (\$1.00) Dollar, receipt and sufficiency of which is hereby acknowledged, does hereby grant and convey to the City of Novi, a Michigan municipal corporation, whose address is 45175 Ten Mile, Novi, Michigan 48375, (hereinafter referred to as "Grantee"), a nonexclusive perpetual easement for storm sewer, over, upon, across, in, through, and under the following described real property, to-wit:

[See attached and incorporated Exhibit B]

and to enter upon sufficient land adjacent to said storm sewer easement for the purpose of exercising the rights and privileges granted herein.

Grantee may install, repair, replace, improve, modify and maintain the storm sewer lines, and all necessary appurtenances thereto, within the easement herein granted.

Grantor agrees not to build or to convey to others permission to build any permanent structures on, over, across, in, through, or under the above-described easement, except that, subject to Grantee's approval as part of an approved site plan, the Grantor may construct and/or install surface improvements to the property, including paved driveways, parking and/or walkways; landscaping; utilities and/or similar improvements, which improvements do not interfere with use, operation, maintenance, repair and replacement of the storm sewer in the easement areas shown on the attached and incorporated Exhibit B.

This instrument shall run with the land first described above and shall be binding upon and inure to the benefit of the Grantor, Grantee, and their respective heirs, representatives, successors and assigns.

IN WITNESS WHEREOF, the undersigned Grantor has affixed his signature this day of June 2, 2021.

GRANTOR:

LAKEMOORE PARKHOMES CONDOMINIUM ASSOCIATION, a Michigan nonprofit corporation,

By: [Signature] BOARD PRESIDENT
Curt Lind Its:

STATE OF MICHIGAN)

)SS

COUNTY OF OAKLAND)

On this 2 day of June, 2021, before me, personally appeared the above named Curt Lind, the President of Lakewood Parkhomes, to me known to be the person described in and who executed the foregoing instrument and acknowledged that they executed the same as his free act and deed.

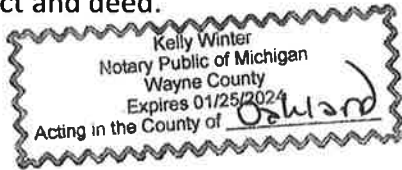

[Signature]
Notary Public
Oakland County, MI
My commission expires 1/25/24

THIS INSTRUMENT DRAFTED BY:

Elizabeth K. Saarela, Esquire
ROSATI SCHULTZ JOPPICH & Amtsbuechler, P.C.
27555 Executive Drive, Suite 250
Farmington Hills, Michigan 48331
AND WHEN RECORDED RETURN TO:

Cortney Hanson, Clerk
45175 Ten Mile
Novi, Michigan 48375

EXHIBIT A - PROPERTY DESCRIPTION SEGMENT 25

PART OF THE SOUTHEAST $\frac{1}{4}$ OF SECTION 25, T.1N., R.8E., CITY OF NOVI, OAKLAND COUNTY, MICHIGAN

THE LAND REFERRED TO IS DESCRIBED AS FOLLOWS: CITY OF NOVI, COUNTY OF OAKLAND, STATE OF MICHIGAN

PART OF THE SOUTHEAST QUARTER OF SECTION 25, TOWN 1 NORTH, RANGE 8 EAST, CITY OF NOVI, OAKLAND COUNTY, MICHIGAN BEGINNING AT THE SOUTH $\frac{1}{4}$ CORNER OF SAID SECTION 25; THENCE N00°08'54"W., 664.05 FEET ALONG THE NORTH AND SOUTH $\frac{1}{4}$ LINE OF SAID SECTION 25; THENCE N89°51'06"E., 216.68 FEET TO THE POINT OF BEGINNING; THENCE N01°09'07"W., 261.55 FEET; THENCE N87°06'37"E., 378.23 FEET; THENCE ALONG THE ARC OF A CURVE TO THE LEFT, RADIUS 543.00 FEET, CENTRAL ANGLE 06°26'42", CHORD 61.05 FEET, CHORD BEARING S03°13'21"E., A DISTANCE OF 61.08 FEET; THENCE S06°26'42"E., 100.00 FEET; THENCE ALONG THE ARC OF A CURVE TO THE RIGHT, RADIUS 457.00 FEET, CENTRAL ANGLE 06°26'42", CHORD 51.38 FEET, CHORD BEARING S03°13'21"E., A DISTANCE OF 51.41 FEET; THENCE S00°00'00"E., 95.84 FEET; THENCE N86°03'21"W., 390.96 FEET, TO THE POINT OF BEGINNING AND CONTAINING 2.524 ACRES.

COPYRIGHT © 2018, All Rights Reserved

AECOM

UTILITY
EASEMENT
NOVI, MI

SURVEY FOR:

CITY OF NOVI
DATE: 03/08/2021
JOB NO. : 63636546
DRAWN: AECOM
CHECKED BY: AECOM



EXHIBIT B - UTILITY EASEMENT

PROPOSED 4' X 10' WIDE UTILITY EASEMENT DESCRIPTION:

COMMENCING FROM THE N.E. CORNER OF SEGMENT 25; THENCE ALONG THE ARC OF A CURVE TO THE LEFT, RADIUS 543 FEET, CENTRAL ANGLE 06°26'42", CHORD 61.05 FEET, CHORD BEARING S03°13'21"E., A DISTANCE OF 26.37 FEET TO THE POINT OF BEGINNING OF A 4' X 10' UTILITY EASEMENT; THENCE ALONG THE ARC OF A CURVE TO THE LEFT, RADIUS 543 FEET, CENTRAL ANGLE 06°26'42", CHORD BEARING S03°13'21"E., 10.00 FEET; THENCE S86°55'55"W., 4.00 FEET; THENCE N03°04'05"W., 10.00 FEET; THENCE N86°55'55"E., 4.00 FEET BACK TO THE POINT OF BEGINNING, CONTAINING 40 SQUARE FEET OF LAND MORE OR LESS.

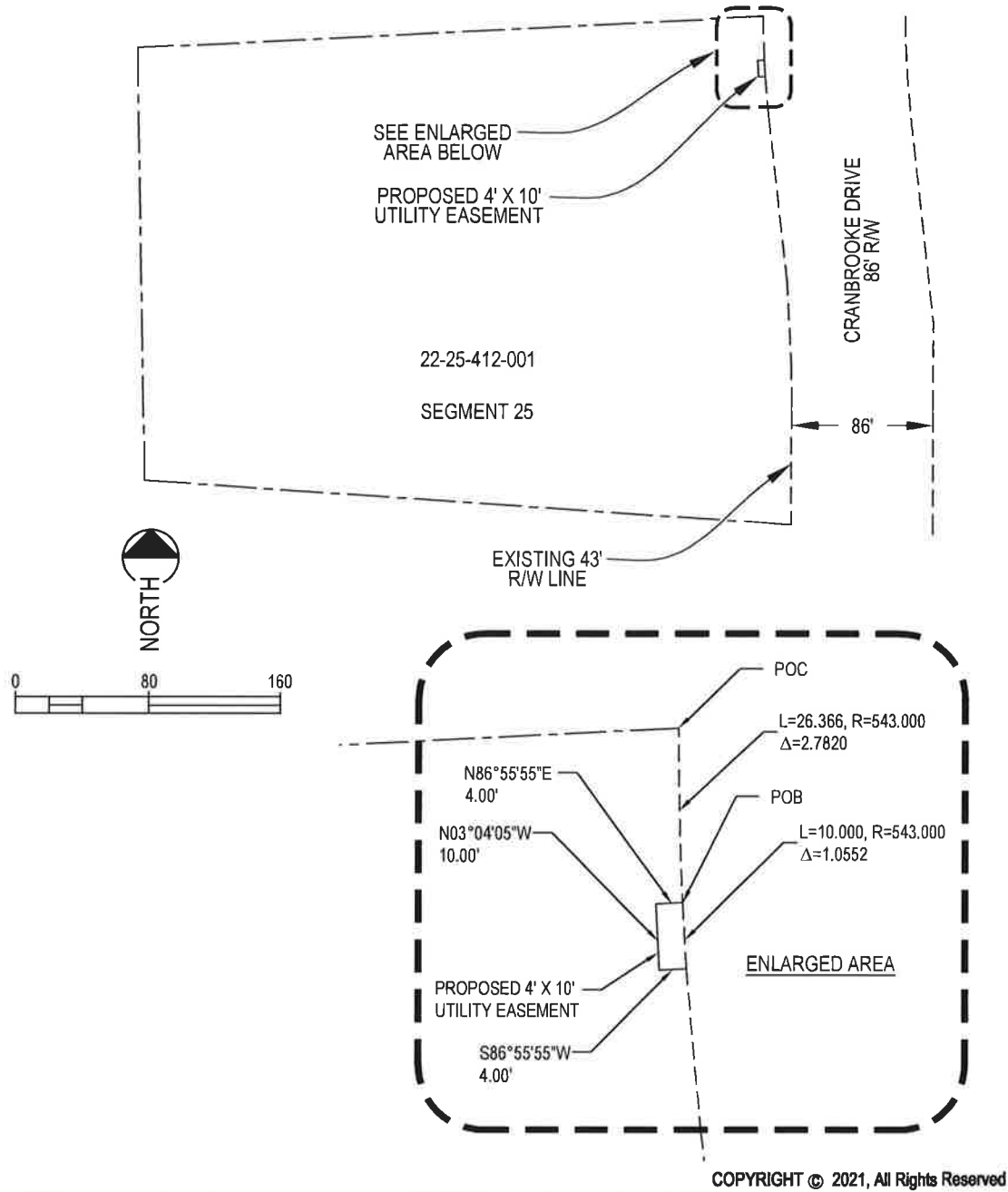

COPYRIGHT © 2021, All Rights Reserved



UTILITY EASEMENT
NOVI, MI

SURVEY FOR:

CITY OF NOVI
DATE: 03/08/2021
JOB NO.: 60636546
DRAWN: AECOM
CHECKED BY: AECOM

LEGEND

PARENT PARCEL
EXISTING R/W LINE
PROPOSED EASEMENT





INVOICE

Invoice Date: **May 24, 2021**

Additional Info:

Customer #:

File Number: **63-21779464-SSP**

Property Address: **Vacant - General Common Element Area, Novi, MI**

RE: **Lakewood Parkhomes Association**

To:
City of Novi 45175 Ten Mile Novi, MI 48375 Attn: Rebecca Runkel

From:
ATA National Title Group, LLC 36800 Gratiot Avenue Clinton Township, MI 48035 Ph:(586) 463-7200 Fax:(586) 463-6114

Description	Amount
Search - Title Information Rep 2300 MI - Basic	\$325.00
Total Premium: \$325.00	

Please Remit To and/or For Closing Information, Please Contact:

ATA National Title Group, LLC
36800 Gratiot Avenue
Clinton Township, MI 48035
Ph:(586) 463-7200 Fax:(586) 463-6114

Thank you!

Commonly Known As: Vacant - General Common Element Area, Novi, MI

TITLE SEARCH

Date: May 12, 2021

The land referred to in this search is situated in the City of Novi, County of Oakland, State of Michigan, as follows:

SEE EXHIBIT A

Last grantee of record:

Lakewoode Parkhomes Condominiums Association, a Michigan nonprofit corporation

1. Agreement with, and restrictions in favor of, Detroit Edison Company and Michigan Bell Telephone Company for the installation and maintenance of electric and communication facilities and ancillary equipment as contained in instrument recorded in Liber 5786, Page 327 and re-recorded in Liber 7229, Page 497, Oakland County Records.
2. Agreement with, and restrictions in favor of, Detroit Edison Company and Michigan Bell Telephone Company for the installation and maintenance of electric and communication facilities and ancillary equipment as contained in instrument recorded in Liber 5933, Page 353 and re-recorded in Liber 7763, Page 539, Oakland County Records.
3. Easement for utilities purposes purposes vested in Consumers Power Company by instrument recorded in Liber 6660, Page 862, Oakland County Records.
4. Easement for water main purposes purposes vested in Colony Club Apartments by instrument recorded in Liber 8961, Page 605, Oakland County Records.
5. Easement for storm sewer purposes vested in Singh Development Company, LTD by instrument recorded in Liber 13772, Page 515, Oakland County Records.
6. Easement for public utilities purposes vested in City of Novi by instrument recorded in Liber 15243, Page 852, Oakland County Records.
7. Easement for public utilities purposes vested in City of Novi by instrument recorded in Liber 15243, Page 855, Oakland County Records.
8. Terms, conditions and provisions which are recited in Consent to Alteration of Common Elements recorded in Liber 10681, Page 418, Oakland County Records.
9. Covenants, conditions, restrictions, easements and right of ways, if any, affecting the common elements.

ATA National Title Group, LLC
36800 Gratiot Avenue
Clinton Township, MI 48035
Ph:(586) 463-7200 Fax:(586) 463-6114

TITLE SEARCH - CONTINUED

10. Rights of the co-owners of Lakewood Parkhomes Condominium in general and limited common elements as set forth in the Master Deed as amended and as described in Act 59 of the Public Acts of 1978 as amended, and all the terms and conditions, regulations, restrictions, easements and other matters set forth in the above described Master Deed and Statutes.

[Easements](#)

[Master Deed 1a](#)

[Master Deed 1b](#)

[Master Deed 1c](#)

[Master Deed 1d](#)

[Master Deed 2](#)

[Master Deed 3](#)

COUNTERSIGNED:

ATA National Title Group, LLC

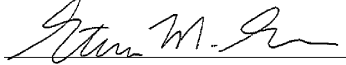

Steven M. Greco

AUTHORIZED SIGNATORY

Terms and Conditions

1. This document is a search only. It is neither an insurance product nor an opinion of law or title and should not be relied upon as such. In addition, it runs only to the named customer and should not be relied upon for any purpose by any person or entity other than the named customer and/or its duly appointed representatives and agents.
2. By receiving and using this product, the customer agrees that the liability of the Company, its subsidiaries and affiliates, for any direct or indirect loss shall be limited to either the amount of the loss or the amount paid for this search, whichever is less.

TITLE SEARCH - CONTINUED

EXHIBIT "A"

The land referred to in this search is described as follows: City of Novi, County of Oakland, State of Michigan

General Common Elements including Community Area, Lakewood Parkhomes Condominium, according to the Superseding Consolidated Master Deed recorded in Liber 6585, pages 408 through 698, both inclusive, and re-recorded in Liber 6605, Pages 34 through 51, both inclusive, and First Corrective Amendment to Superseding Consolidated Master Deed recorded in Liber 7646, Pages 647 through 652, both inclusive, Second Amendment to Superseding Consolidated Master Deed recorded in Liber 9430, Pages 469 through 479, both inclusive, Amended and Restated Superseding Consolidated Master Deed recorded in Liber 43088, Pages 32 through 103, both inclusive, Oakland County Records, as amended, and designated as Oakland County Condominium Subdivision Plan No. 212, together with rights in general common elements and limited common elements as set forth in the above-described Master Deed, as amended, and as described in Act 59 of the Public Acts of 1978, as amended.

22-25-412-001, as to Community Area

22-25-430-000